



Automotive Electronics

Applications Guide

Use Our Deep Experience for Your Automotive Application

About this guide

This guide provides a summary of key circuit protection consideration factors, descriptions of the technologies Littelfuse offers, and product selection tables. It is designed to help you quickly find a protection solution appropriate to your application.

Topic	Page
Electrical Threats and New Automotive Technologies	4-5
Automotive Applications in Modern Vehicles	6-7
Automotive Circuit Protection Applications Matrix	8-11
Energy Storage System	12
Battery Module	13
On-board Battery Charger	14
Traction Motor Inverter	15
DC/DC Converter	16
Battery Distribution Unit	17
Active Clamping	18
Ignition System	19
Motor Control	20
Engine Cooling System	21
Infotainment and Navigation	22
Vehicle Communication	23
Emergency Call (eCall)	24
Sensor Fusion	25
Radar System	26
Camera	27
Remote Keyless Entry	28
Lighting – Inside Cabin	29
Lighting – Headlamps	30
Global Lab Capabilities	31

Specifications, descriptions, and illustrative material in this literature are as accurate as known at the time of publication, but are subject to changes without notice. Visit Littelfuse.com for more information.

1930 Littelfuse invents the first automotive fuse



1950 Introduces industry's first centralized under-dash fuse block



1976 The first blade-type ATO (Autofuse®) Fast Acting Fuse, now considered the global standard



2017 Develops 1200V SiC MOSFET for battery charging applications



Littelfuse: Everywhere, Every Day

Founded in 1927, Littelfuse has become the world's most respected circuit protection brand, with well-established and growing platforms in power control and sensing technologies. Today, we are a global company, offering a diverse and extensive product portfolio—fuses, semiconductors, polymers, ceramics, relays, sensors, and more—serving the electronics, automotive, and industrial markets. Each is manufactured to exacting quality standards and backed by an unwavering commitment to technical support and customer service.

Our history of innovation, combined with our customer-first culture, drives us to collaborate with you to develop safer, more reliable products that are energy efficient and compliant with global regulations. We will partner with you to solve complex problems wherever electrical energy is used, bringing design, engineering, and technical expertise to deliver business results.

Why Choose Littelfuse

Littelfuse introduced the first of what would become a long line of automotive circuit protection technologies in the 1930s, with the design and development of the original automotive fuses. That commitment to the automotive industry continues today as vehicles have become increasingly dependent on high-powered electronics.

Littelfuse supports automotive designers with a global network of test labs and design and manufacturing facilities across four continents, including China's second-largest semiconductor fabrication facility. Our Silicon Valley Technology Center supports the complete innovation life cycle, from new materials and product concepts to product design, prototyping, testing, and validation.

Customer Focus

A customer-first approach is at the heart of our company-wide culture, driving us to build long-lasting relationships and exceed expectations. Every day, it's our employees who make the difference for your business. They listen to your needs and understand your challenges. They use their knowledge and expertise to develop the best solutions and solve your problems.

Application Expertise

At Littelfuse, we partner with customers to design, manufacture, and deliver innovative solutions for a wide range of markets including automotive and commercial vehicles, industrial applications, data and telecommunications, medical devices, consumer electronics, appliances, and transportation. Our expertise involves applying reliable and efficient product solutions, innovative technologies, and global resources to address technical challenges in a variety of applications. Our worldwide network of research teams focuses on product development and support, design-in programs, and application testing in our global labs.

Operational Excellence

With our global manufacturing footprint, Littelfuse is firmly committed to manufacturing quality products at a competitive price. We build quality into our products and services, striving for zero defects in everything we do, thereby reducing cost and increasing your total satisfaction. We strive to exceed your expectations every day.

Quality Assurance

Our global manufacturing facilities abide by strict quality assurance requirements and hold the following quality management system registrations:

- ISO 9001
- ISO14001
- IATF 16949

Protect. Control. Sense.

Littelfuse offers leading technologies in circuit protection, power control, and sensing. We continue to expand our broad and diverse portfolio of products into adjacent markets, including Power Semiconductors, heavy-duty Switches, Magnetic, Optical, Electromechanical, and Temperature Sensors as well as other products that provide safe control and distribution of electrical power.

Electrical Threats and New Automotive Technologies



THREAT: ELECTROSTATIC DISCHARGE (ESD)

ESD is characterized by fast rise times and high peak voltages and currents up to 30A, which can melt silicon and conductor traces. Even when ESDs don't cause catastrophic failures, electrical currents due to ESD can change the state of internal logic, causing a system to latch up and behave unpredictably or cause corruption of a data stream. Without adequate protection, ESD can damage control units, infotainment electronics, sensors, fuel injectors, valves, motors, powertrains, and dozens of other components. Sometimes, a component or circuit is damaged by ESD, creating latent defects that later progress to premature failures.



TVS Diode Arrays

Because of their high-speed response to overvoltages, TVS Diode Arrays are widely used for ESD protection in automotive electronics. Automotive-qualified SPA[®] TVS Diode Arrays from Littelfuse are available in a range of compact surface-mount packages to fit into any layout.

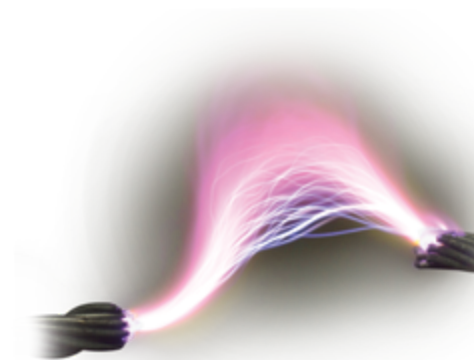

THREAT: OVERLOADS/SHORT-CIRCUIT CURRENTS

Sustained overloads will cause circuit components to overheat, potentially leading to catastrophic and uncontrolled failures of the vehicle's electrical system. Short circuits can surpass the capabilities of the wires, connectors, etc. in the power circuit, which can also lead to uncontrolled failures or possibly a thermal event.

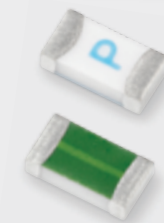

Fuses

Automotive Fuses protect components or circuits by melting under overcurrent conditions to interrupt current flow. In addition to withstanding rapid temperature cycles and vibration, they must offer long-term stability and AEC-Q test compliance. Littelfuse offers an unparalleled range of automotive Fuses, from cartridge and blade styles to surface-mount chip Fuses.



Resettable PPTC Overcurrent Protection Devices

Littelfuse Polymeric Positive Temperature Coefficient (PPTC) devices are widely used in automotive applications like wiring harness and network protection, communication and infotainment systems, and EV battery management systems. Unlike Fuses, these devices provide resettable protection for automotive electronics against damage from harmful overcurrent surges. Bladed, leaded, and surface-mount form factors are available for automotive applications.



THREAT: SWITCHING LOADS IN POWER ELECTRONICS CIRCUITS

In modern automotive designs, all on-board electronics are connected to the battery and the alternator. However, the output of the alternator is unstable and requires further conditioning before it can be used to power the vehicle's other systems. During the powering or switching of inductive loads, the power is temporarily interrupted, and unwanted voltage spikes or transients are generated. If left unchecked, these transients would be transmitted along the power line and into the electronic modules.



Varistors

Automotive-qualified Metal Oxide Varistors (MOVs) and Multilayer Varistors (MLVs) protect against voltage transients induced by load dump and other transient events. When exposed to high-voltage transients, the varistor impedance changes by many orders of magnitude—from a near open-circuit to a highly conductive level—clamping the transient voltage to a safe level. Choose from radial-leaded MOVs in disc sizes from 5mm to 20mm. Also, surface-mounted MLVs are available.



OPPORTUNITY: ELECTRIFYING THE VEHICLES OF TOMORROW

Researchers predict that by 2025, a typical high-end vehicle will contain more than \$6,000 worth of electronics. The growing interest in self-driving vehicles, vehicle-to-vehicle and vehicle-to-infrastructure communications, and on-board safety, convenience, and environmental features ensures that the sheer number of electronic components per vehicle will continue to expand rapidly. Additionally, as hybrid-electric vehicles become increasingly popular, power semiconductors will be critical to the next generation of Battery Management Systems and on-board/off-board charging systems.



Power Semiconductors

Power semiconductor devices enable the next generation of vehicles by managing power flexibly. Fast-switching SiC technology increases power density and energy efficiency in systems like on-board battery chargers. The Littelfuse power semiconductor portfolio includes Thyristors, Rectifiers, Fast Recovering Diodes, IGBTs, and wide band gap devices.

Automotive Applications in Modern Vehicles

The Littelfuse portfolio of AEC-Q101-qualified (TVS diodes and diode Arrays) and AEC-Q200-qualified (varistors, multilayer varistors, and PPTCs) components helps to protect the growing number of electronic applications in modern vehicles.

From ultra-low capacitance Diode Arrays for ESD protection of to high-speed signal lines, including Ethernet, USB 3.1, and HDBase, to our high-surge formulation AUMOV® varistors, Littelfuse has the solutions and expertise to match your technical and application challenges.

COMMUNICATION & INFOTAINMENT SYSTEMS

- Radio
- Power Audio
- GPS Module
- Satellite Navigation
- Portable Navigator
- Navigation System
- Telematics Box
- Car Multimedia

NETWORK SYSTEMS & BODY

- CAN Bus
- LIN Bus
- FlexRay*
- MOST*
- Bluetooth*
- BroadR-Reach®
- Safe-By-Wire*
- Central Body Module
- Lighting Power Window
- Retracting Mirror
- Wiper
- Dashboard
- Climate Control
- Keyless Entry
- Seat Control
- Park Assistance

CHASSIS & SAFETY SYSTEMS

- Active Suspension
- Tire Pressure Monitoring System (TPMS)
- Electric Power Steering (EPS)
- Seat Belt Pretensioning
- Precrash
- Battery Disconnect
- Antiroll-over
- Stability Control
- Brake Control
- DC Power Supply
- Air Bag
- ABS
- Radar

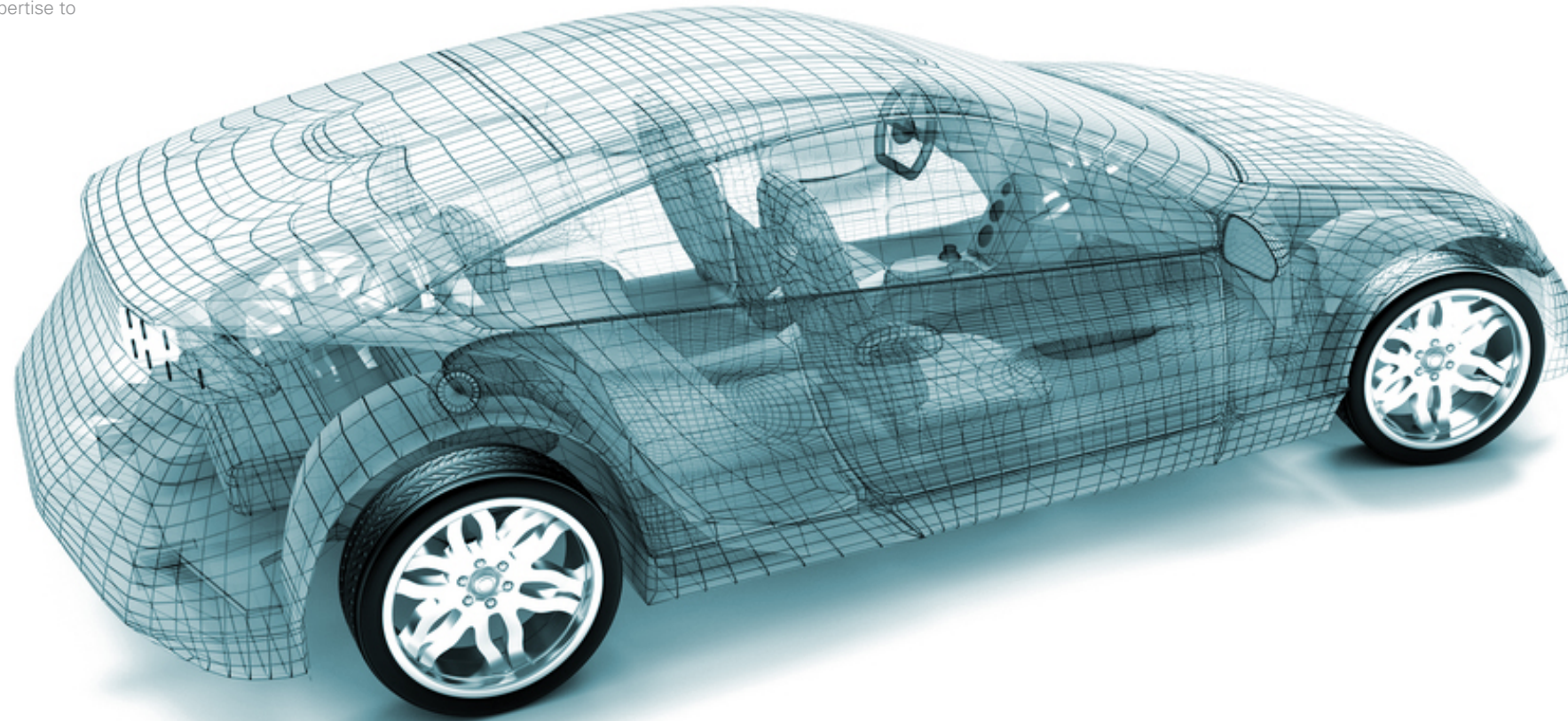

POWERTRAIN SYSTEMS

- Automatic Cruise Control (ACC)
- Electronics Control Unit (ECU)
- Turbo Charger
- Selespeed*
- Transmission Control Unit (TCU)
- Battery Charging
- Injection
- GDI

NEW ENERGY CAR

- Gas Electric
- Fuel Cell Electric
- Diesel Electric
- Li-Ion and NiMH Battery Electric
- Ultracapacitors
- Battery Management System (BMS)

ADVANCED DRIVER ASSISTANCE SYSTEMS

- Night Vision
- Pedestrian Avoidance
- Lane Departure Sensing
- Adaptive Cruise Control
- Vehicle-to-Vehicle (V2V) Communication
- Interior Camera – Driver Monitoring
- Exterior Camera – Front View
- Exterior Camera – Rear View Park Assist
- Blind Spot Detection
- Side Impact Assist
- Automated Headlight Control

Ignition IGBTs

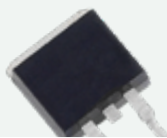

Switching semiconductor devices for ignition circuits

SM24CANA Diode Arrays



Safeguard automotive CAN Bus from ESD damage

TPSMD TVS Diodes



Protect electronic circuits against system-generated transients

AXGD Series



Protects high-frequency and RF circuits from ESD

AUML & Auto MLA Varistors



Designed to suppress destructive surges and ESD

AUMOV® Varistors



Suppress high-energy transients in AC and DC circuits

Surface Mount PPTCs



Resettable overcurrent protection for DC circuits

Surface Mount Fuses



Provide safety protection against overcurrent events

Littelfuse experts support customers' designs in accordance with worldwide automotive safety standards. By contributing their own experience to the development of new standards, Littelfuse engineers help to ensure the safety and reliability of the next generation of circuit protection products.

Littelfuse engineers help customers understand which standards apply in terms of both the application itself and the geographical location for which it is designed, as well as offer guidance on how to meet those standards. Littelfuse offers a broad line of circuit protection devices certified compliant with these standards.

- **Transient surges:** JASO and ISO 7637-2 (Surge) test
- **Electrical disturbance by conduction and coupling:** ISO 7637-2
- **Electrical disturbances from electrostatic discharge:** ISO 10605
- **Environmental conditions and testing for electrical and electronics equipment:** ISO 16750-2
- **Load dump, switching transients, and ESD threats:** SAE J1113, GM 9105, ES-F2af-1316-AA Ford (Visteon)

Electrical component qualification:

- **AEC-Q101:** failure-mechanism based stress test qualification for discrete semiconductors in automotive applications
- **AEC-Q200:** stress test qualification for passive electrical devices

* The marks BroadR-Reach®, FlexRay, MOST, Bluetooth, Safe-By-Wire, and Selespeed are the properties of their respective owners.

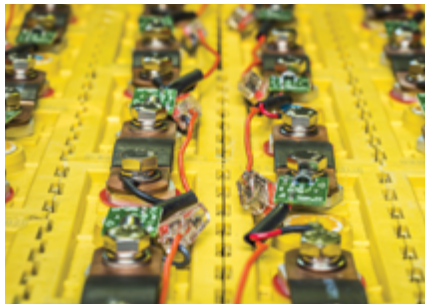

ENERGY STORAGE SYSTEM

The energy storage system, which includes the battery management system, stores and supplies electric power for all vehicle needs. Obviously critical, this system needs protection from a wide range of electrical threats, such as high-fault currents, voltage transients, overcurrent, and overloads. Each threat is best countered with the right type of circuit protection technology.

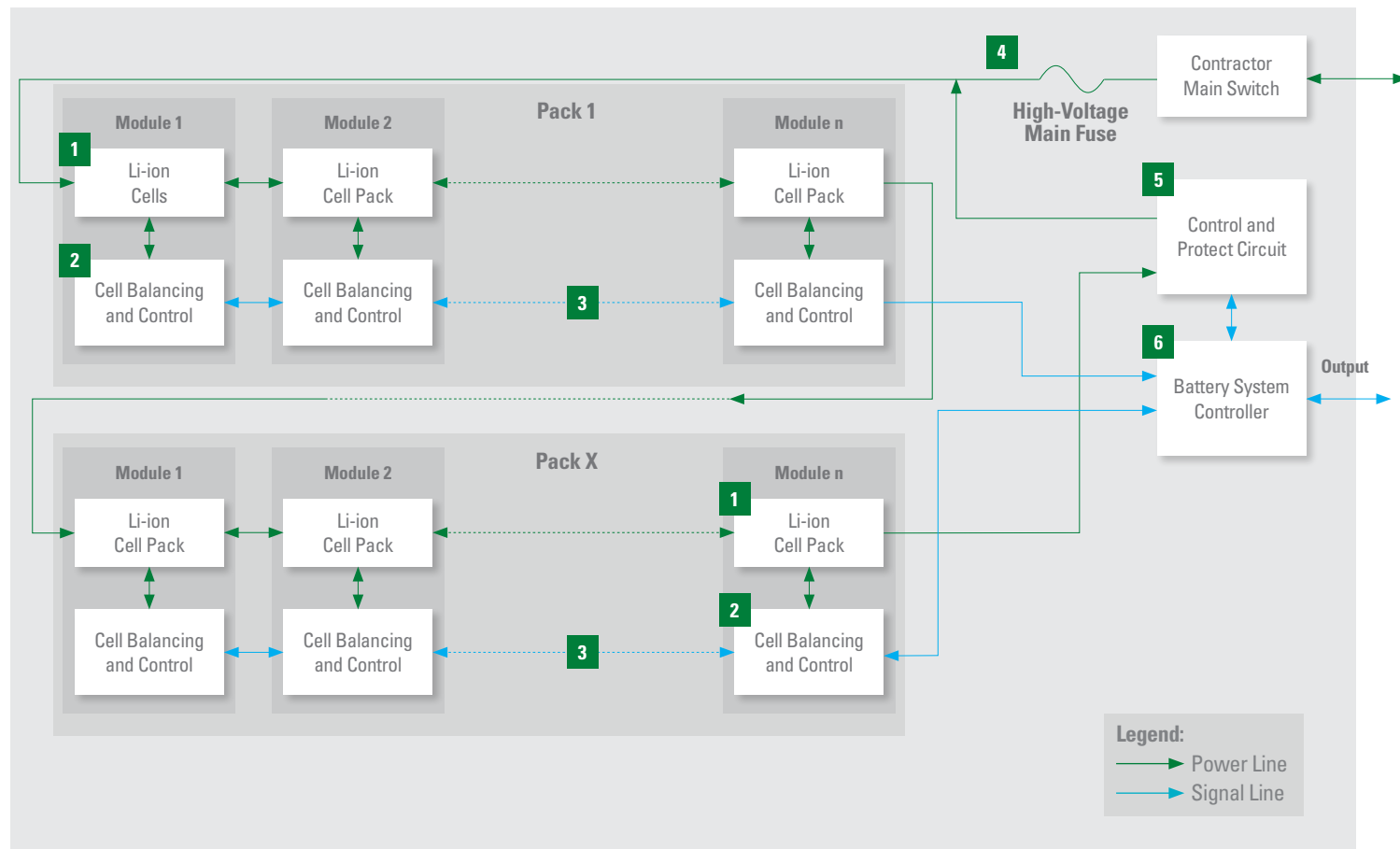

BATTERY MODULE

Inside the battery pack is a number of battery modules made up of individual battery cells. This architecture dictates that layers of circuit protection are required. At the module level, the battery module and cable should be protected from overcurrent and from overloads between power-sense lines. The electronics should be defended against voltage transients, and the CAN and other communication buses should be safeguarded from ESD and voltage transients.

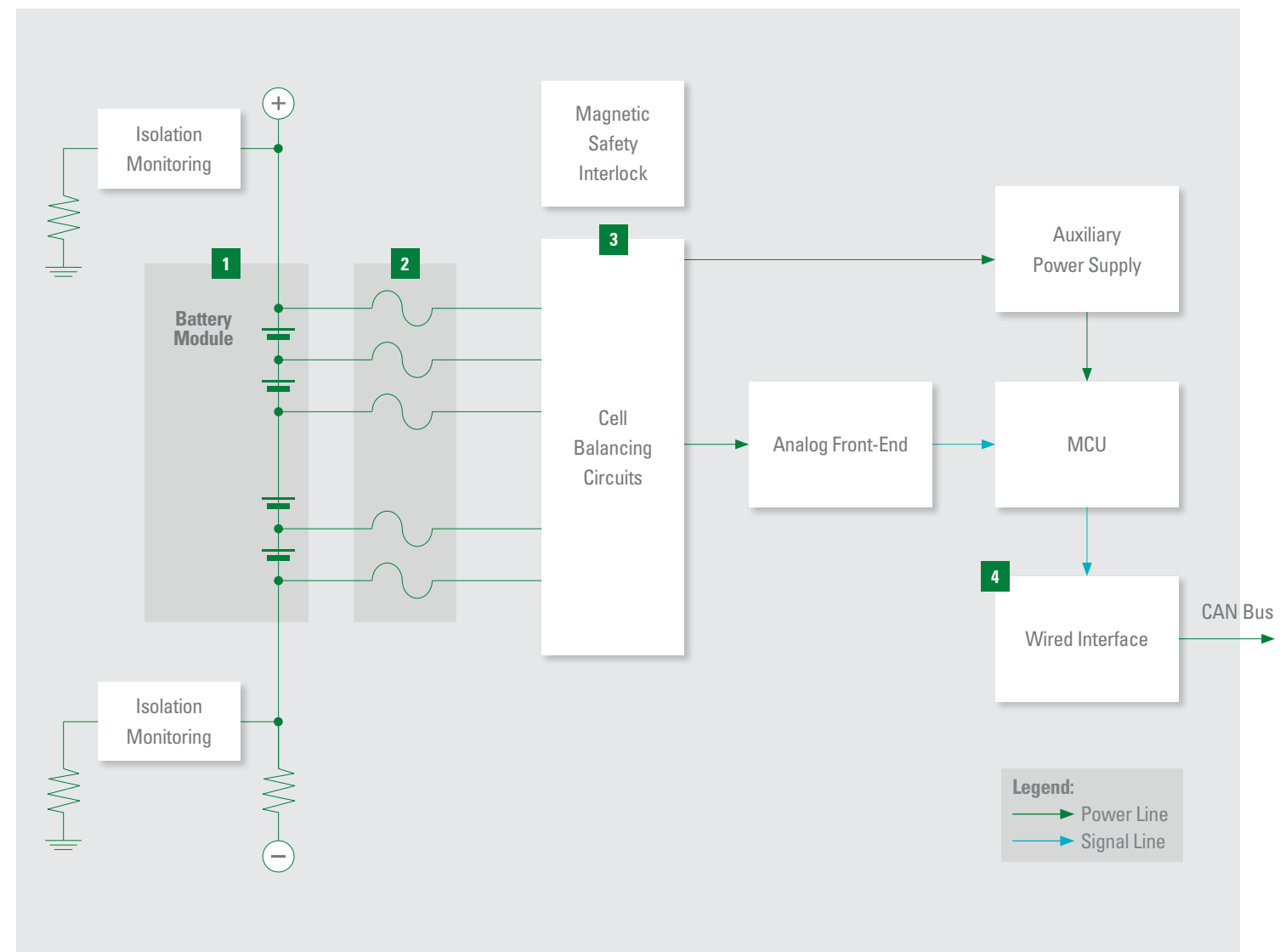

	Technology	Application	Series Name	Features
1	SMD Fuse	Protects cells and downstream BMS components from high-fault currents due to external shorts	501A, 881A	Tested to new AECQ specification, fast response to fault current, surface mount device
	TVS Diode	Transient Voltage Suppression	TPSMC, SZ1SMC, SZ1.5SMC	AEC-Q101 qualified, meets IEC standards for ESD protection and ISO for in-vehicle transient surges
2	SMD or Inline Fuse	Protects cells and BMS components from overcurrent	438A, 441A, 521	Tested to new AECQ specification, fast response to fault current, surface mount device
	TVS Diode	Transient Voltage Suppression	TPSMB, SZ1SMB, SZP6SMB	AEC-Q101 qualified, meets IEC standards for ESD protection and ISO for in-vehicle transient surges
3	TVS Diode	Transient Voltage Suppression	AQ05C	AEC-Q101 qualified, meets IEC standards for ESD protection and ISO for in-vehicle transient surges
	Diode Array	Protects sensitive electronic ICs from ESD, EFT and voltage transient	TPSMA6L, SZ1SMA	AEC-Q101 qualified, meets ESD protection levels specified under IEC 61000-4-2, ISO10605, low leakage current and clamping voltage
4	High-Voltage Fuse	Short circuit protection Overload circuit protection	SHEV, 20HEV	Bolt down form factor, high breaking capacity, qualified to ISO 8820 standard
5	Gate Driver	Controls the switching MOSFETs	IXD, 6xxSI	Tight tolerance, small form factor, fast thermal response
	Diode Array	Protect CAN Bus from ESD, EFT and voltage transient	AQ24CAN	AEC-Q101 qualified, meets ESD protection levels specified under IEC 61000-4-2, ISO10605, low leakage current and clamping voltage
6	SMD Fuse	Protects cells and BMS components from overcurrent	885	Tested to new AECQ specification, fast response to fault current, surface mount device
	TVS Diode	Transient Voltage Suppression	TPSMB, TPSMC	AEC-Q101 qualified, meets IEC standards for ESD protection and ISO for in-vehicle transient surges

	Technology	Application	Series Name	Features
1	High-Voltage Fuse	Protect battery pack module and cable from overcurrent	885, 521	Third party compliance UL/ISO, low internal resistance, shock safe, vibration resistant
2	Low-Voltage Fuse	Analog front-end protection of user and environment in case of external short, overload between power-sense line	437A, 438A, 440A	Surface mountable, compatible with lead-free solder process per IEC standards, high reliability
3	TVS Diode	Protect sensitive electronic components from voltage transients	TPSMB	600W peak pulse capability, compatible with lead-free solder reflow temperature profile
4	Diode Array	Protect CAN Bus sensitive electronic ICs from ESD, EFT and voltage transient	AQ24CANA, SZ1SMB	AECQ-101 qualified, low capacitance, low leakage current



ON-BOARD BATTERY CHARGER

Hybrid and electric vehicle batteries can be recharged from standard power outlets by using an AC-DC converter system, or directly from DC power that is covered outside of the vehicle for faster charging. Design challenges include protecting against overcurrents, overvoltages and ESD, as well as controlling switching of the input rectifiers. Littelfuse offers a broad range of High Voltage Fuses, Varistors, GDTs, Switching Thyristors and TVS Diodes and Diode Arrays to address these threats.

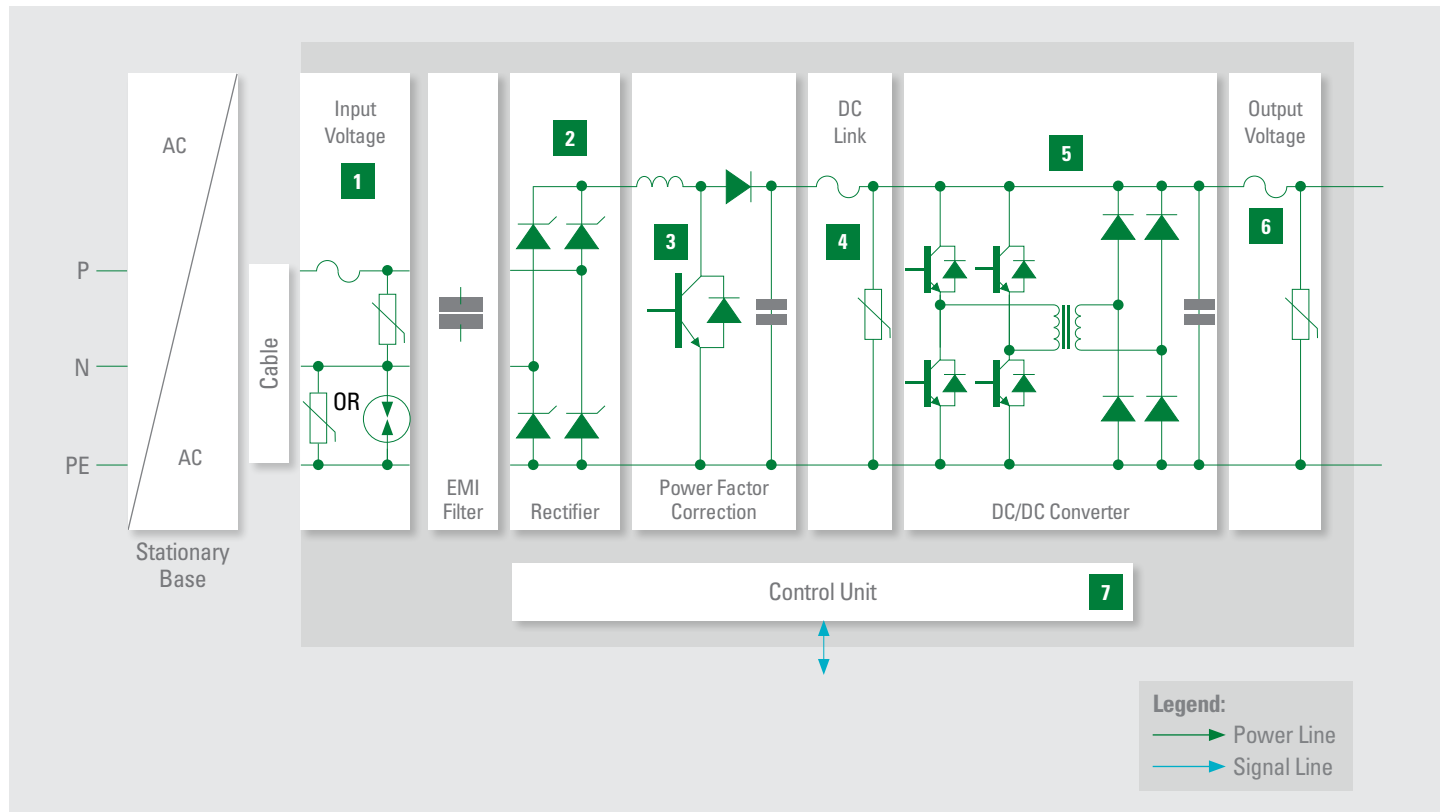

	Technology	Application	Series Name	Features
1	Fuse	Short circuit protection Overload circuit protection	10EV*, 20EV	Bolt down form factor, high breaking capacity, qualified to ISO 8820 standard
	Metal Diode Varistor (MOV)	Lightning and system transient surges	AUMOV	Wide range of surge current ratings, disk sizes and lead options
	GDT	Ensures electrical isolation between line, neutral and ground	CG2, CG3	Rugged, high surge current based on ceramic tube design, low leakage current
	SIDACTor	Lightning and system transient surges	Pxxx0FNL, Pxxx0SD	Surface mount form factor, semiconductor-based design provides no wear-out capability
2	Thyristor	Rectification	S8016xA	Compact TO-220AQ and surface mount TO-263 form factors, Vdrm of 800V, It or 25A (rms)
3	Gate Driver	Controls the switching IGBTs	IXD_6xxSI, IX4340NE	Tight tolerance, small form factor, fast thermal response
4	TVS Diode	Active clamping	TPSMB High Voltage	Small form factor DQ214-AA package, low clamping voltage, products are available with voltage ratings from 150V-650V. For more information on Active Clamp see here
5	Gate Driver	Controls the switching IGBTs	IXD_6xxSI, IX4340NE	Tight tolerance, small form factor, fast thermal response
	TVS Diode	Active clamping	TPSMB High Voltage	Small form factor DQ214-AA package, low clamping voltage, products are available with voltage ratings from 150V-650V. For more information on Active Clamp see here
6	Diode Array	ESD protection of the gate input	AQ4022	AEC-Q101 qualified, meets ESD protection levels specified under IEC 61000-4-2, ISO10605, low leakage current and clamping voltage
	Fuse	Short circuit protection Overload circuit protection	10EV*, 20EV	Bolt down form factor, high breaking capacity, qualified to ISO 8820 standard
	Metal Diode Varistor (MOV)	Transient Voltage Suppression	AUMOV	Wide range of surge current ratings, disk sizes and lead options
7	TVS Diode	Transient Voltage Suppression	TPSMB, SZ1SMB, SZP6SMB	AEC-Q101 qualified, meets IEC standards for ESD protection and ISO for in-vehicle transient surges
	Diode Array	Protect CAN Bus from ESD, EFT and voltage transient	AQ24CANA	AEC-Q101 qualified, meets ESD protection levels specified under IEC 61000-4-2, ISO10605, low leakage current and clamping voltage

* Please contact us for more details



TRACTION MOTOR INVERTER

The traction motor inverter changes DC current from the battery into the AC current needed to drive the traction motor of an electric or hybrid electric vehicle. Littelfuse offers a variety of components across this system, starting with a fuse on the power supply and ending with thermal protection on the motor.

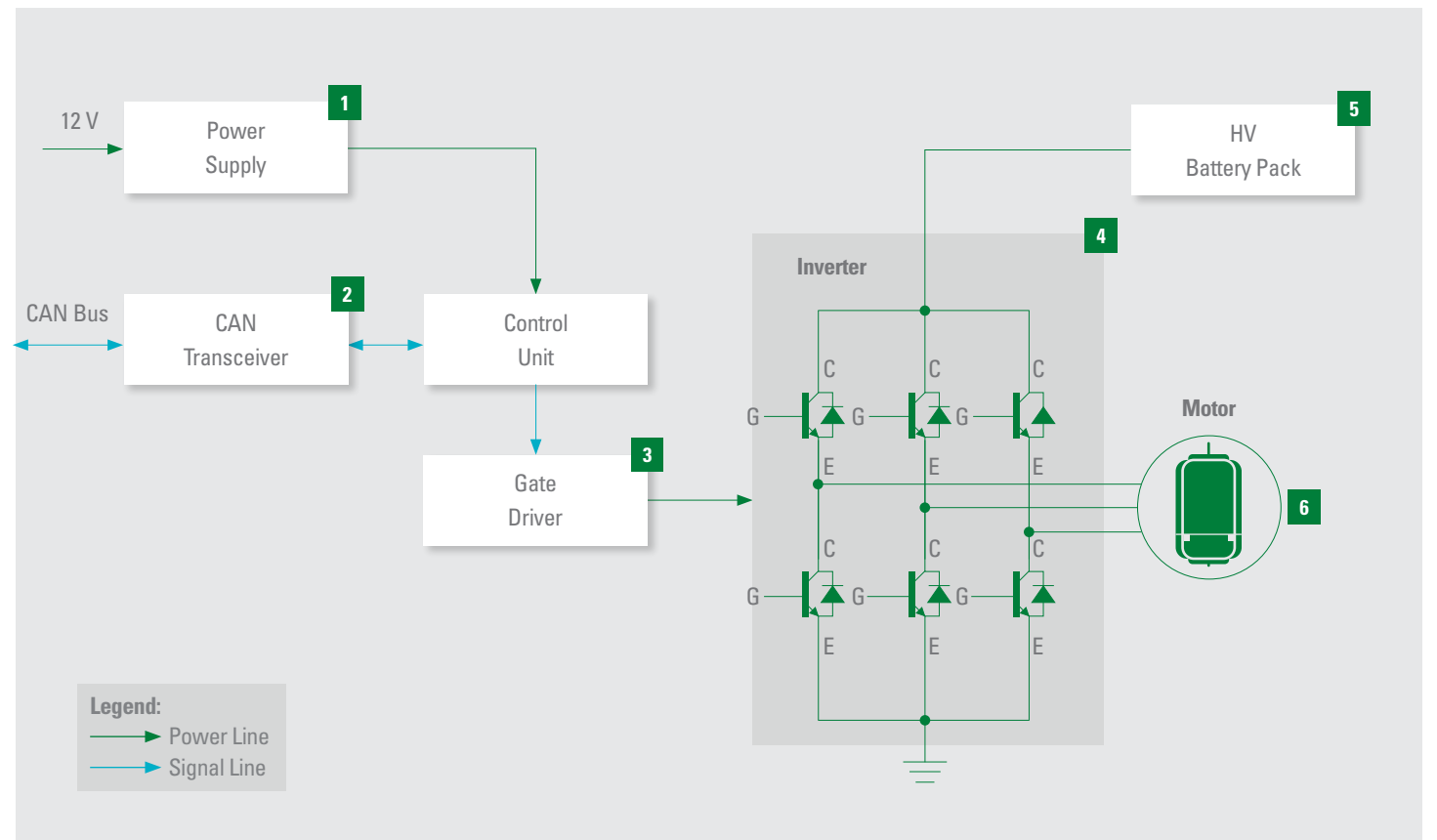

	Technology	Application	Series Name	Features
1	TVS Diode	Transient Voltage Suppression	TPSMB, TPSMAGL, SZ1SMB, SZP6SMB, SZ1SMA	AEC-Q101 qualified, meets IEC standards for ESD protection and ISO for in-vehicle transient surges
	SMD Fuse	Short circuit protection Overload circuit protection	441A	Tested to new AECQ specification, fast response to fault current, surface mount device
2	Diode Array	Protect CAN Bus from ESD, EFT and voltage transient	AQ24CANA	AEC-Q101 qualified, meets ESD protection levels specified under IEC 61000-4-2, ISO10605, low leakage current and clamping voltage
3	Diode Array	ESD protection of the gate input	AQ4022	AEC-Q101 qualified, meets ESD protection levels specified under IEC 61000-4-2, ISO10605, low leakage current and clamping voltage
	TVS Diode	Transient Voltage Suppression	TPSMF4L, SZSME	AEC-Q101 qualified, meets IEC standards for ESD protection and ISO for in-vehicle transient surges
4	Gate Driver	Controls the switching IGBTs	IXD_6xxSI, IX4340NE	Tight tolerance, small form factor, fast thermal response
	TVS Diode	Active clamping	TPSMB High Voltage	Small form factor DQ214-AA package, low clamping voltage, products are available with voltage ratings from 150V-650V. For more information on Active Clamp see here
5	Fuse	Short circuit protection	525*, 526*, 527*	High voltage, ceramic body ensures compatibility with high temperature environment
6	TVS Diode	Transient Voltage Suppression	TPSMB	AEC-Q101 qualified, meets IEC standards for ESD protection and ISO for in-vehicle transient surges
	Thermal Protector	Thermal protection for MOSFETs	HCRTP-mini	Surface mountable form factor, compatible with standard reflow process, breaks current flow during overtemperature condition

* Please contact us for more details

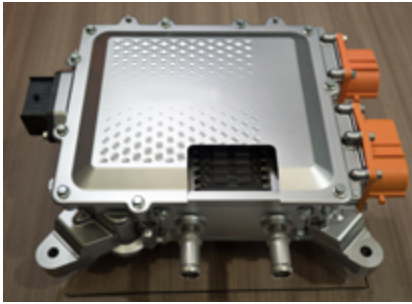

DC/DC CONVERTER

The DC/DC converter changes the high voltage from the battery to a lower level of voltage, which is needed by a wide range of onboard systems: 12 V loads, including lighting, sensors, and entertainment, and 48 V loads, including heating, powertrain, and air conditioning. Littelfuse IGBT Gate Drivers control the switching MOSFETs for energy-efficient power conversion. Power semiconductor devices are vulnerable to electrical threats, which is why circuit protection is particularly important.

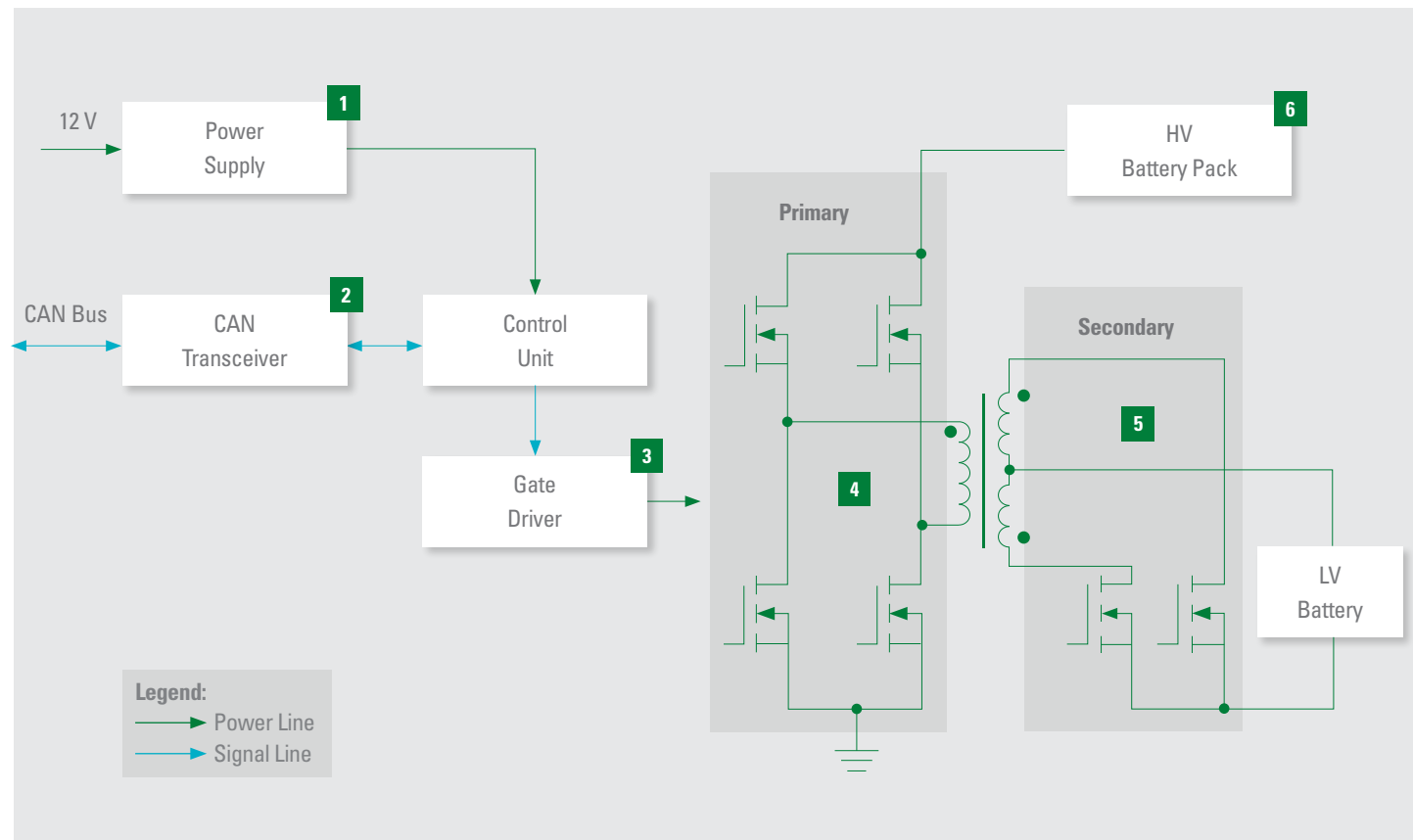

BATTERY DISTRIBUTION UNIT

A battery distribution unit is like the vehicle's junction/panel box, delivering power to the many systems that need it. In electric vehicles, the unit relies on high-current, high-voltage fuses and contactors. Drawing upon its deep experience in the automotive industry, Littelfuse provides both fuses and contactors that are reliable and safe for this emerging application.

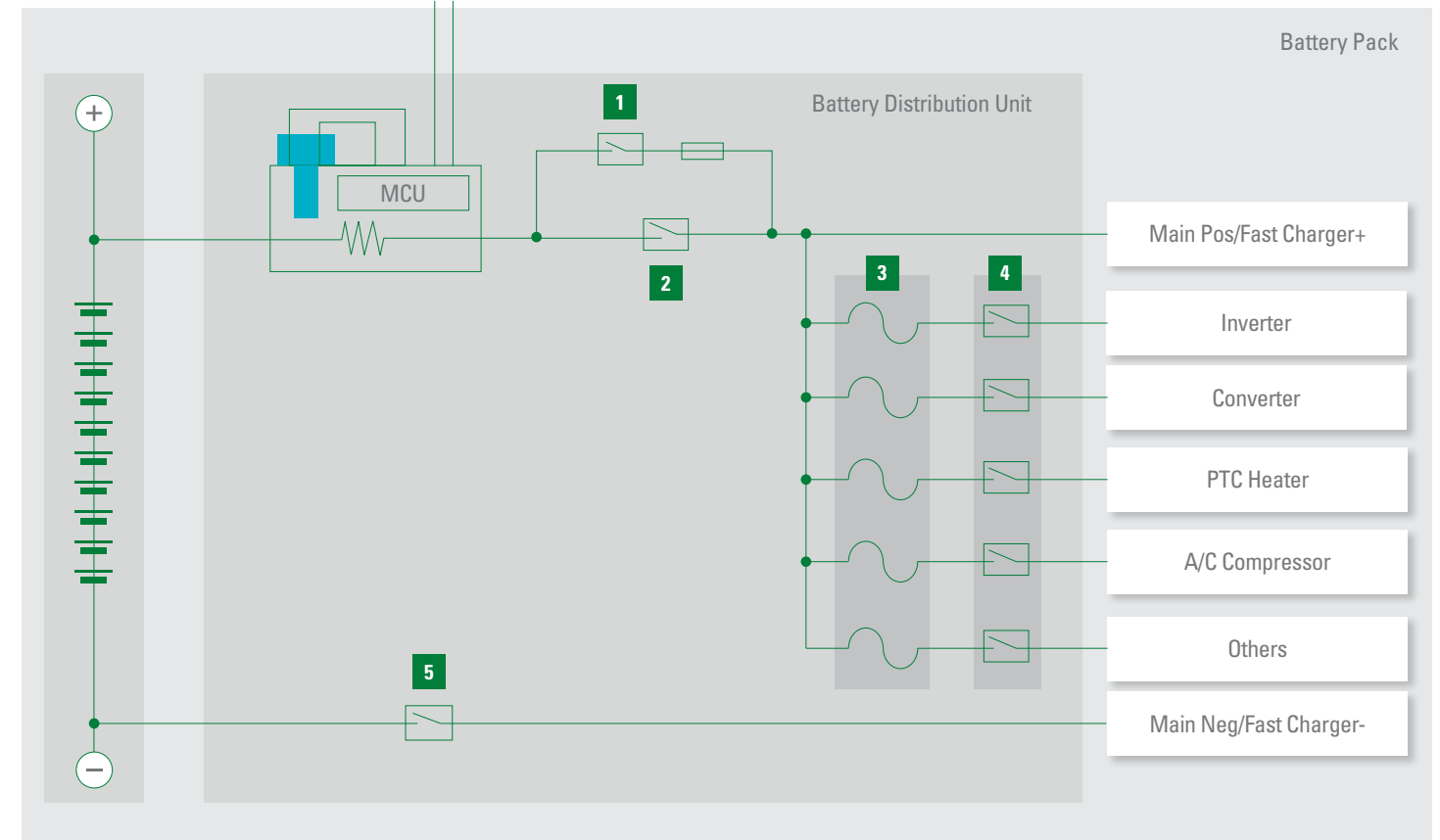

	Technology	Application	Series Name	Features
1	TVS Diode	Transient Voltage Suppression	TPSMB , TPSMA6L , SZ1SMB , SZP6SMB , SZ1SMA	AEC-Q101 qualified, meets IEC standards for ESD protection and ISO for in-vehicle transient surges
	SMD Fuse	Short circuit protection Overload circuit protection	441A	Tested to new AECQ specification, fast response to fault current, surface mount device
	Thermal Protector	Thermal protection for MOSFETs	HCRT-mini	Surface mountable form factor, compatible with standard reflow process, breaks current flow during overtemperature condition
2	Diode Array	Protect CAN Bus from ESD, EFT and voltage transient	AQ24CANA	AEC-Q101 qualified, meets ESD protection levels specified under IEC 61000-4-2, ISO10605, low leakage current and clamping voltage
	Diode Array	ESD protection of the gate input	AQ4022	AEC-Q101 qualified, meets ESD protection levels specified under IEC 61000-4-2, ISO10605, low leakage current and clamping voltage
3	Diode Array	Transient Voltage Suppression	TPSMF4L	AEC-Q101 qualified, meets IEC standards for ESD protection and ISO for in-vehicle transient surges
	Gate Driver	Controls the switching MOSFETs	IXD_6xxSI , IX4340NE	Tight tolerance, small form factor, fast thermal response
4	TVS Diode	Active clamping	TPSMB.HighVoltage	Small form factor DO214-AA package, low clamping voltage, products are available with voltage ratings from 150V–650V. For more information on Active Clamp see here
5	Fuse	Short circuit protection	525*, 526*, 527*	High voltage, ceramic body ensures compatibility with high temperature environment
	Thermal Protector	Thermal protection for MOSFETs	HCRT-mini	Surface mountable form factor, compatible with standard reflow process, breaks current flow during overtemperature condition
6	TVS Diode	Active clamping	TPSMB.HighVoltage	Small form factor DO214-AA package, low clamping voltage, products are available with voltage ratings from 150V–650V. For more information on Active Clamp see here
	Gate Driver	Controls the switching MOSFETs	IXD_6xxSI , IX4340NE	Tight tolerance, small form factor, fast thermal response

* Please contact us for more details

	Technology	Application	Series Name	Features
1	Pre-charge Contactor	Used to protect the main contactors from an excess inrush current, a pre-charge resistor is used together with a pre-charge capacitor to charge the capacitors of the power inverter to a level of typically 90-98% of the battery voltage	DCNSEV , DCNLEV	Wide range of capabilities—can switch from 10s of amps to 1000s of amps, and 10s of volts to 1000s of volts
2	Main Positive Contactor	The main contactors connect and disconnect the traction battery from the entire electric drivetrain in the vehicle	DCNEV	Wide range of capabilities—can switch from 10s of amps to 1000s of amps, and 10s of volts to 1000s of volts
3	Auxiliary Fuse	Short circuit protection Overload circuit protection	10EV*, SHEV , 20HEV	Bolt down form factor, high breaking capacity, qualified to ISO 8820 standard
4	Auxiliary Contactor	Control other electrical loads in the vehicle that are operated by the HV battery (for example, electric heater, blower, A/C compressor, power steering pump, etc.)	DCNEV , DCNSEV	Wide range of capabilities—can switch from 10s of amps to 1000s of amps, and 10s of volts to 1000s of volts
5	Main Negative Contactor	The main contactors connect and disconnect the traction battery from the entire electric drivetrain in the vehicle	DCNEV	Wide range of capabilities—can switch from 10s of amps to 1000s of amps, and 10s of volts to 1000s of volts

* Please contact us for more details



ACTIVE CLAMPING

Insulated Gate Bipolar Transistors (IGBTs) are widely used in power inverters, electric vehicle chargers, and motor control because of their ease of use and their high-voltage and current driving capabilities. Active clamping switching technology offers a solution that illustrates how modern, high-power IGBTs can be used with reliability, especially in high-speed railway and automotive traction applications. A high-voltage TVS diode is a critical component for IGBT active clamping during an IGBT turn-off event, and helps in operating an IGBT in a safe and active mode.

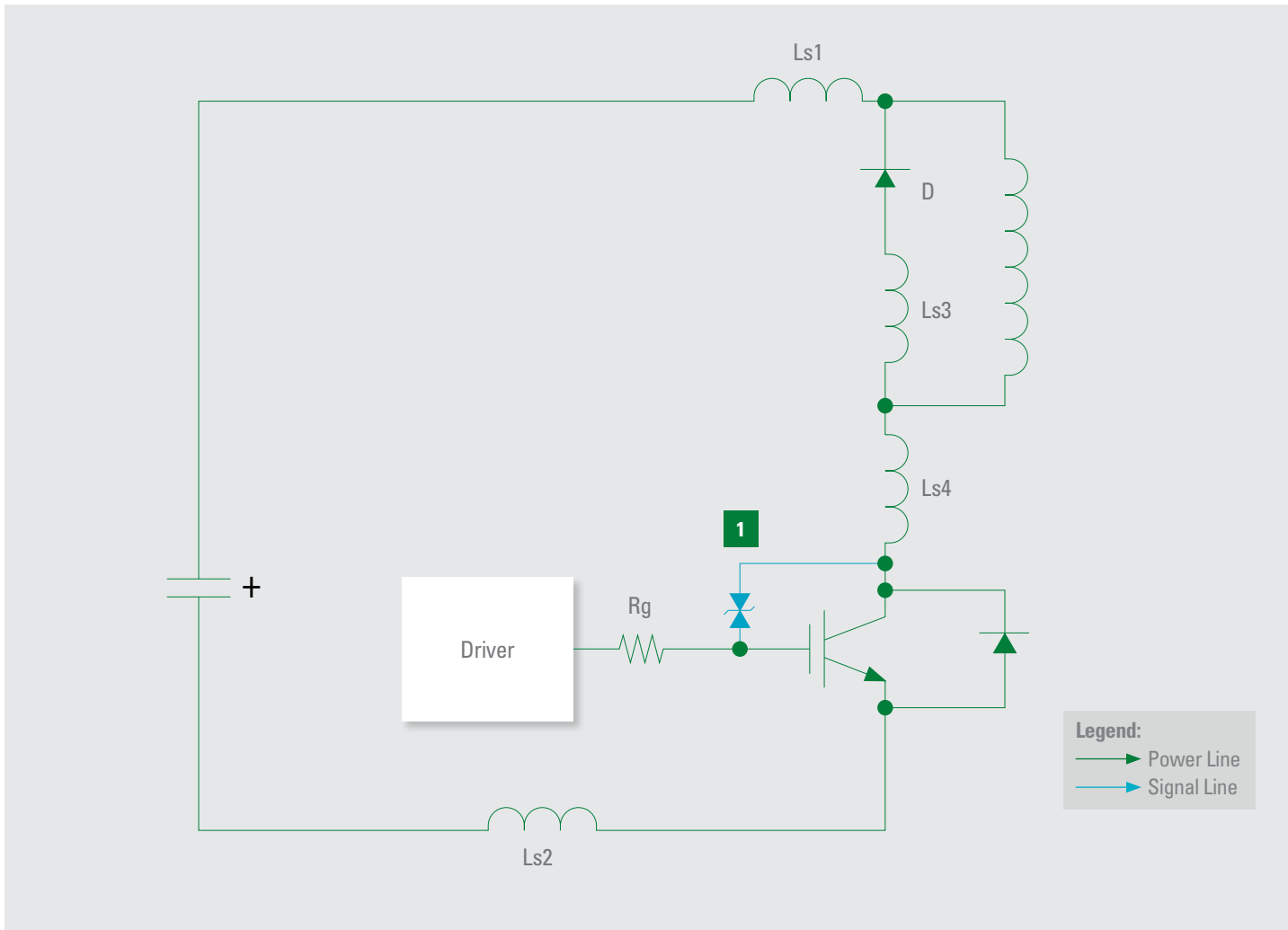

	Technology	Application	Series Name	Features
1	TVS Diode	IGBT active clamping protection	TPSMB High Voltage	Provide active clamping based on the DC power line voltage and IGBT Vce voltage, products are available with voltage ratings from 150V-650V. For more information on Active Clamp see here



TPSMB TVS Diode



IGNITION SYSTEM

The efficiency of gasoline engines and consequently their mileage and emissions are dependent on the performance of the ignition system. The latter must be protected against variety of threats, including load dumps, feedback loops, and overcurrents. In addition to high-performance Ignition IGBTs, Littelfuse offers a broad portfolio of protection devices like TVS Diodes, MLVs, PPTCs, and Fuses.

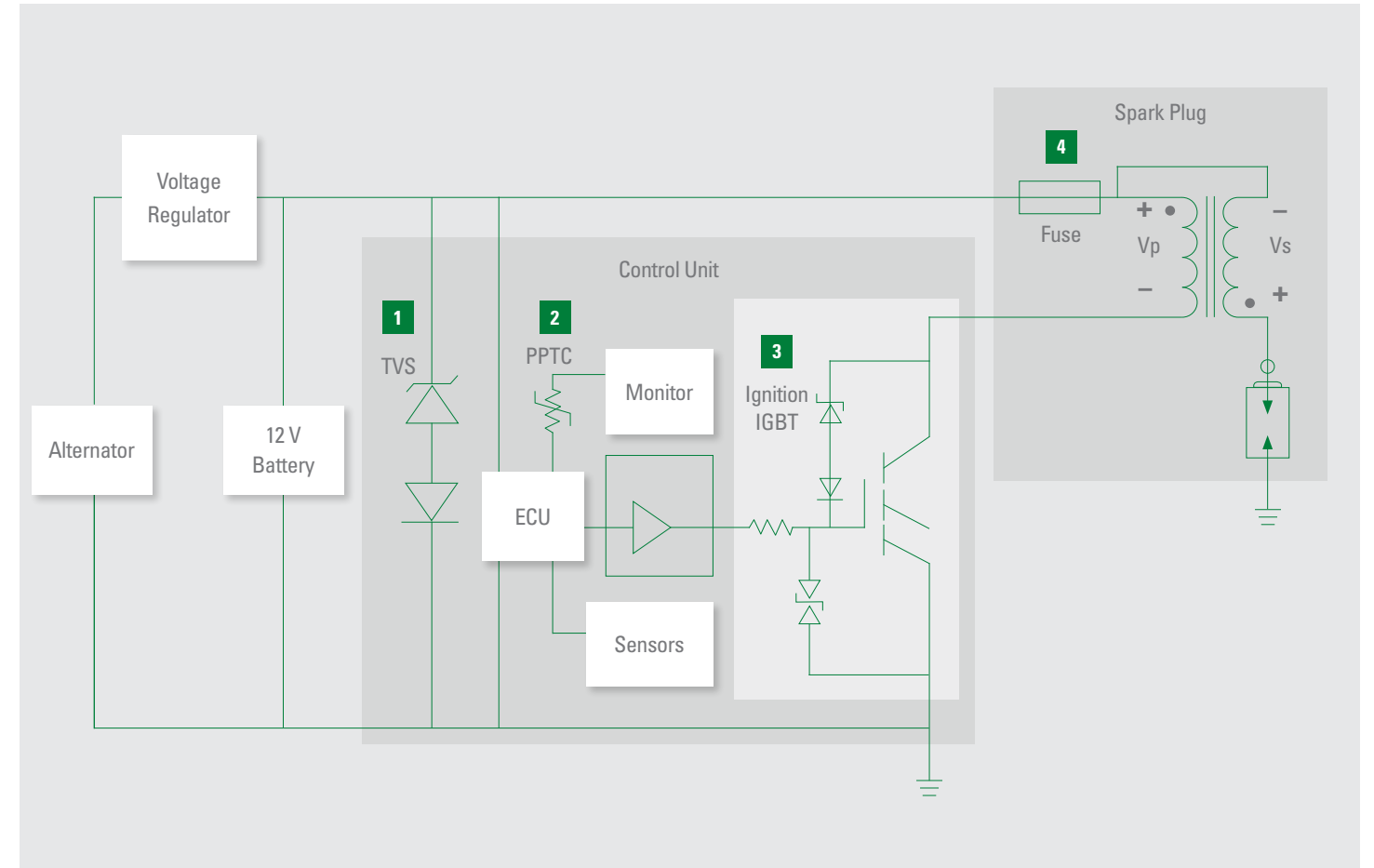

	Technology	Application	Series Name	Features
1	TVS Diode	Load dump protection	SLD8S, TPSMB	TVS Diode for ISO16750 5a/5b load dump protection
	Multilayer Varistor (MLV)		AUML	Multilayer varistor with load dump energy rating per SAE Specification J1113
2	SMD PPTC	Feedback loop protection	miniASMD, miniASMDCH	Resettable SMD overcurrent protection up to 2.6A
3	IGBT	Ignition	NGB, NGD	Ignition IGBTs with integrated ESD and overvoltage clamping protection above 350 Vbr
	TVS Diode	Active clamping protection	TPSMB High Voltage	Provides active clamping based on the DC power line voltage and IGBT Vce voltage, products are available with voltage ratings from 150V-650V. For more information on Active Clamp see here
4	SMD Fuse	Coil overcurrent protection	440A, 441A	High I ² t SMD fuse for applications up to 63Vdc and 8A



miniASMD PPTC



SLD8S TVS Diode Array



NGB IGBT

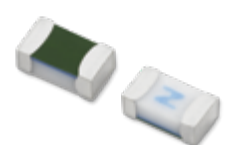

441A SMD Fuse



MOTOR CONTROL

As mechanical/hydraulic actuators are replaced with electric motors, such as those for electric parking, braking, seat modules, and mirrors, motor control circuit protection is critical to a vehicle's overall reliability. Potential threats include load dump, overcurrents, surges, and ESD. Littelfuse offers a wide range of TVS Diodes and Diode Arrays, MLVs, MOVs, and PPTCs to protect motor control applications.

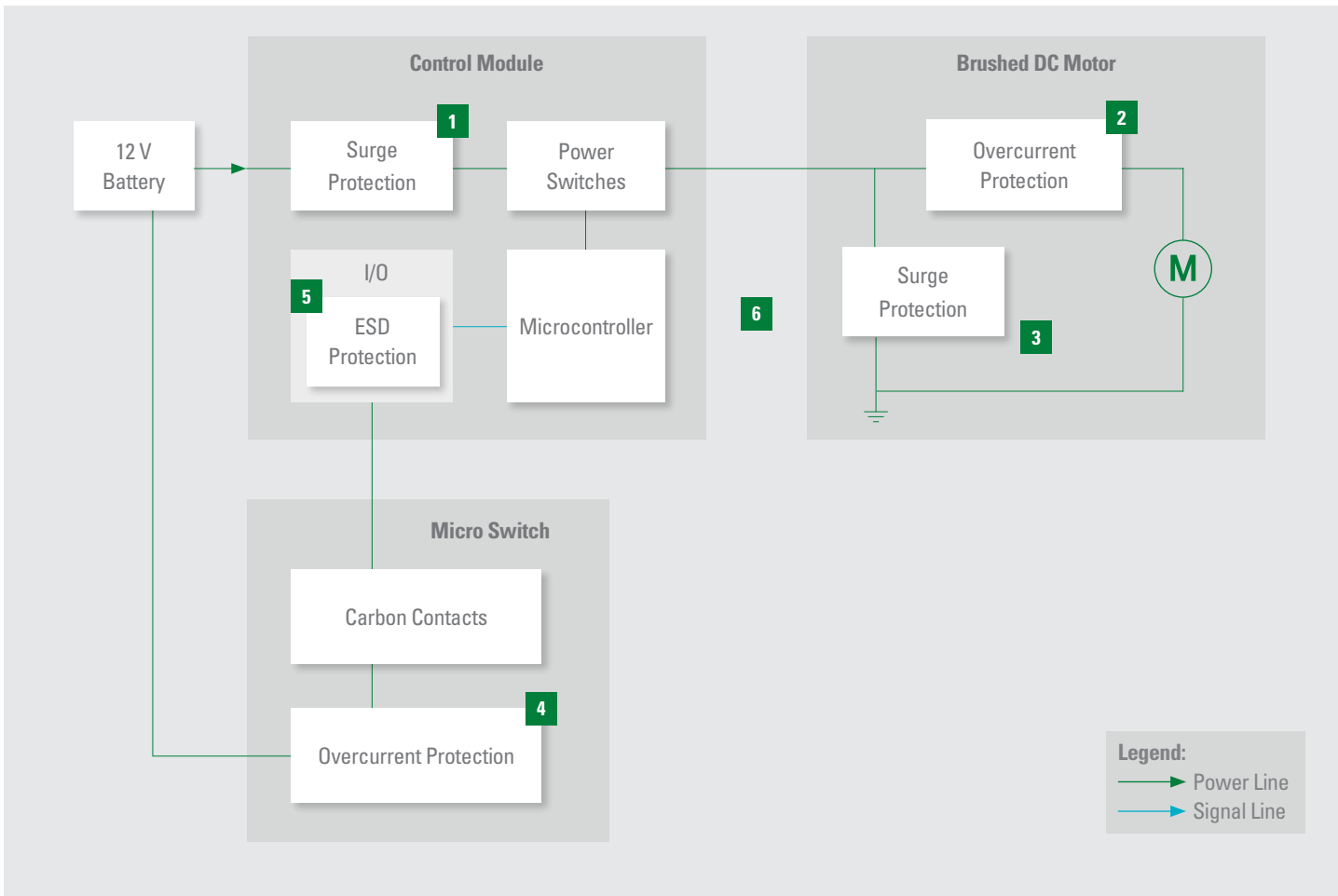

	Technology	Application	Series Name	Features
1	TVS Diode	Load dump protection	SLD8S , TPSMB , TPSMD	TVS Diode for ISO16750 5a/5b load dump protection
	Multilayer Varistor (MLV)		AUML	Multilayer Varistor with load dump energy rating per SAE specification J1113
	TVS Diode	Standard surge protection	SZ1SMA , SZ1SMB , TPSMA6L , TPSMB , TPSMC , TPSMD	TVS Diode for secondary induced transient voltages with peak pulse capability from 400W to 5000W
2	PPTC	Overcurrent protection	TD , CHIP , Rline	Normally custom made to fit into the motor housing. By mounting them close to the motor windings, they will trip more quickly when the motor windings are hot and therefore closer to being damaged, and more slowly when the motor windings are cold
3	Metal Oxide Varistor (MOV)	Overvoltage protection	AUMOV	Radial-leaded MOV with up to 10kA surge current and 2.5kV isolation voltage capability up to 125°C
4	SMD PPTC	Overcurrent protection	miniASMD , miniASMDCH	Resettable SMD overcurrent protection up to 3A
5	Diode Array	ESD protection	AQ1003 , AQ1005 , SP1326	Industry-standard solution for ESD protection up to 8A
6	TVS Diode	Overvoltage protection	TPSMB , TP6KE	TVS Diode for secondary induced transient voltages with peak pulse capability from 400W to 5000W
	TVS Diode	Load dump protection	SLD8S	TVS Diode for ISO16750 5a load dump protection



ENGINE COOLING SYSTEM

Engines depend on a steady flow of cooling fluid to maintain optimal performance. Engine cooling systems need protection against threats, such as load dump, surges, ESDs, and overheating. The growing range of Littelfuse solutions includes TVS Diodes and Diode Arrays, MLVs, MOVs, Schottky Diodes, and SMD PPTCs.

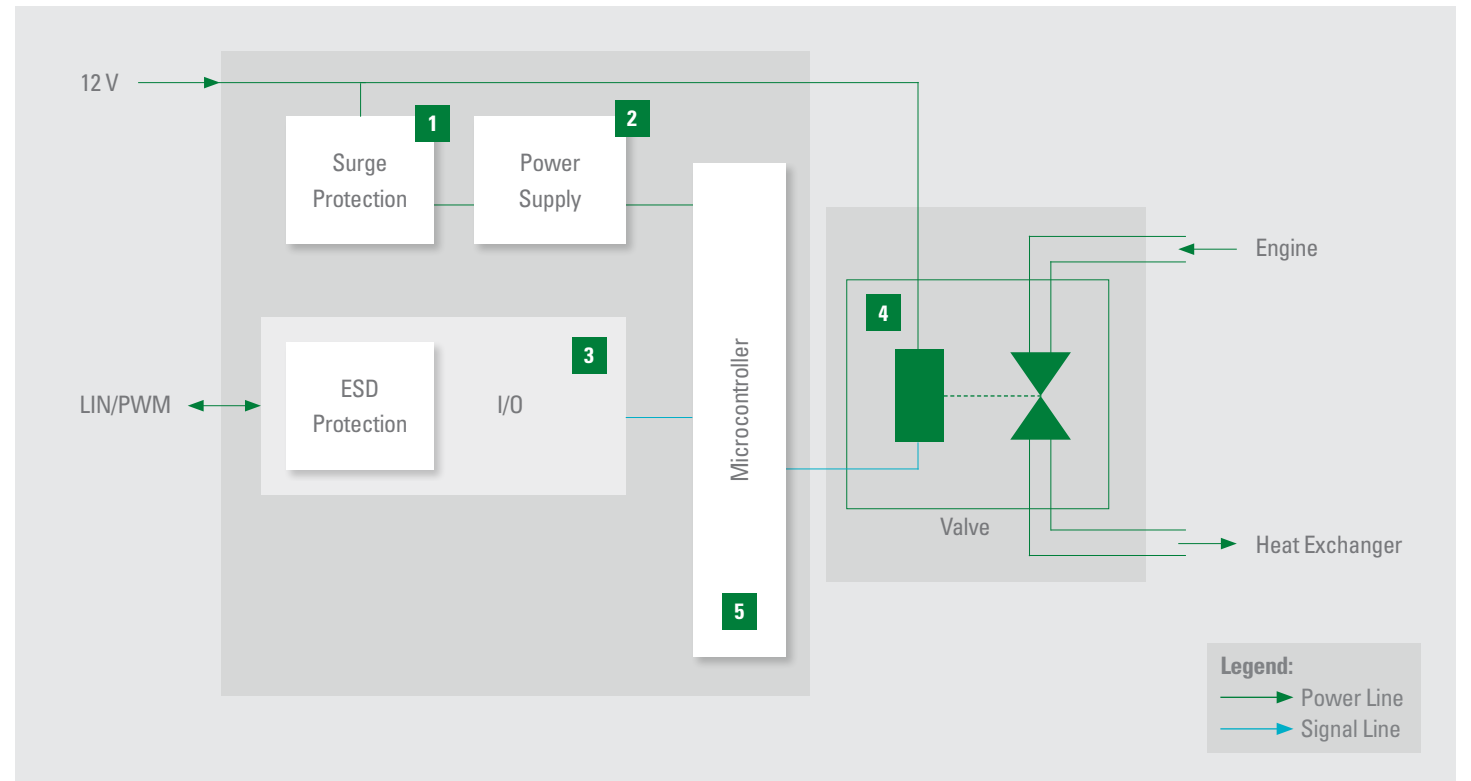

	Technology	Application	Series Name	Features
1	TVS Diode	Load dump protection	SLD8S	TVS Diode for ISO16750 5a/5b load dump protection
	Multilayer Varistor (MLV)		AUML	Multilayer Varistor with load dump energy rating per SAE specification J1113
	TVS Diode	Standard surge protection	SZ1SMA , SZ1SMB , TPSMA6L , TPSMB , TPSMC , TPSMD	TVS Diode for secondary induced transient voltages with peak pulse capability from 400W to 5000W
	SMD PPTC	Reverse polarity protection	miniASMD , ASMD , miniASMDCH	Resettable SMD overcurrent protection up to 3A
	Schottky Diode		DST	Ultra-Low V_f Schottky Barrier Rectifier meets the general requirements of automotive applications by providing high temperature capability, low leakage, and low forward voltage drop to 100V and 10A
2	Schottky Diode	Reverse blocking/output rectification	DST	Ultra-low V_f Schottky Barrier Rectifier meets the general requirements of automotive applications by providing high temperature capability, low leakage, and low forward voltage drop
3	Diode Array	PWM (IO) protection	AQ1005 , AQ3102 , AQ3522	General purpose ESD Diodes in multiple package options and ESD capability of 30kV
	Diode Array	LIN Bus ESD protection	AQ24C	Industry-standard solution for ESD and surge protection for LIN Bus
4	Metal Oxide Varistor (MOV)	Switching element protection	AUMOV	Radial-leaded MOV with up to 10kA surge current and 2.5kV isolation voltage capability up to 125°C
5	TVS Diode	Standard surge protection	SZ1SMA , SZ1SMB , TPSMA6L , TPSMB , TPSMC , TPSMD	TVS Diode for secondary induced transient voltages with peak pulse capability from 400W to 5000W



INFOTAINMENT AND NAVIGATION

Entry-level cars today integrate advanced electronic systems that were once more typical of high-end cars, including infotainment, telematics, and connectivity. Potential threats to these advanced systems include overcurrents, ESD, and surges. Littelfuse delivers comprehensive protection solutions, including SMD Fuses, SMD PPTCs, TVS Diodes and Diode Arrays, MLVs, and XTREME-GUARD™ ESD Suppressors.

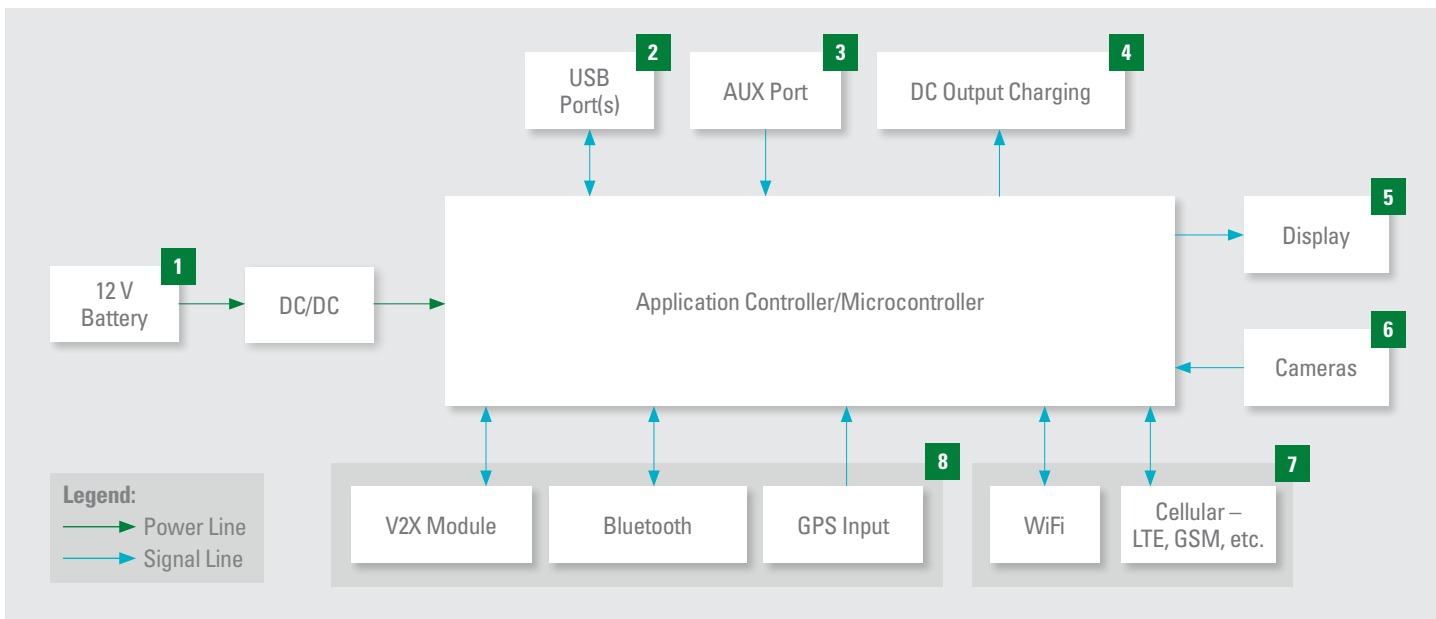

	Technology	Application	Series Name	Features
1	SMD Fuse	Short circuit protection	437A, 440A, 441A	Tested to new AECQ specification, fast response to fault current, surface mount device
	SMD PPTC		ASMD, miniASMD	AEC-Q200 qualified, small footprint 2029/1812 size
	TVS Diode	Load dump protection	SZ1SMB, SLD8S	AEC-Q101 qualified, meets IEC standards for ESD protection and ISO for load dump protection
	Multilayer Varistor (MLV)		AUML, MLA Auto	AEC-Q200, load dump energy rated per SAE specification J1113, surface mount device
	Schottky Diode		DST	Ultra-low V _f , high temperature capability, low leakage, low forward voltage drop to 100V and 10A
2	SMD PPTC	Protect 5VDC power supply from overcurrent and overtemperature	ASMD, miniASMD	Ultra-low internal resistance, higher current holding in small SMD package
	Diode Array	Protection of data lines against ESD	AQ1005	Low capacitance 30pF and leakage current 0.1µA, small form factor SOD882
Multilayer Varistor (MLV)	MLA Auto		AEC-Q200 compliant, standard low capacitance	
3	Diode Array	Protection of aux port against ESD	AQ1005	Low capacitance 30 pF and leakage current 0.1µA, small form factor SOD882
	Multilayer Varistor (MLV)		MLA Auto	AEC-Q200 compliant, standard low capacitance
4	SMD Fuse	Secondary overcurrent protection on DC charging port	437A, 440A, 441A	Tested to new AECQ specification, fast response to fault current, surface mount device
	TVS Diode	Secondary ESD protection	SZ1SMB, SLD8S	AEC-Q101 qualified, meets IEC standards for ESD protection and ISO for load dump protection
	Multilayer Varistor (MLV)		AUML, MLA Auto	AEC-Q200, load dump energy rated per SAE specification J1113, surface mount device
5	Diode Array	High-speed ESD protection	AQ3045	AEC-Q101 qualified, low capacitance 0.35pF, low leakage current 100nA, small form factor SOD882
6	SMD PPTC	Overcurrent protection of high-speed data lines in camera	ASMD, miniASMD	AEC-Q200 qualified, small footprint 2029/1812 size
	Diode Array	Protection of data lines against ESD	AQ1005, AQ3045	Low capacitance and leakage current, small form factor
	Multilayer Varistor (MLV)		MLA Auto	AEC-Q200 compliant, standard low capacitance
7	Diode Array	ESD protection for antenna, WiFi, and other chipset	AQ3045, AQ3130, AQ3118	AEC-Q101 qualified, low capacitance, low leakage current, small form factor
	Polymer ESD		AXGD	AEC-Q200 qualified, ultra-low capacitance, low leakage current
8	Diode Array	ESD protection for Bluetooth, GPS, and V2X modules	AQ3045, AQ3130, AQ3118	Low capacitance 30pF and leakage current 0.1µA, small form factor SOD882
	Multilayer Varistor (MLV)		MLA Auto	AEC-Q200 compliant, standard low capacitance
	Polymer ESD		AXGD	AEC-Q200 qualified, ultra-low capacitance, low leakage current



VEHICLE COMMUNICATION

V2V and V2I will provide new levels of safety and efficiency by sharing data on vehicle locations and speed/direction, as well as receiving information from smart traffic signals. On-board power and communication circuits in these systems need overcurrent, ESD, and surge protection using Fuses, PPTCs, TVS Diodes and Diode Arrays, MLVs, and Polymer ESD Suppressors.

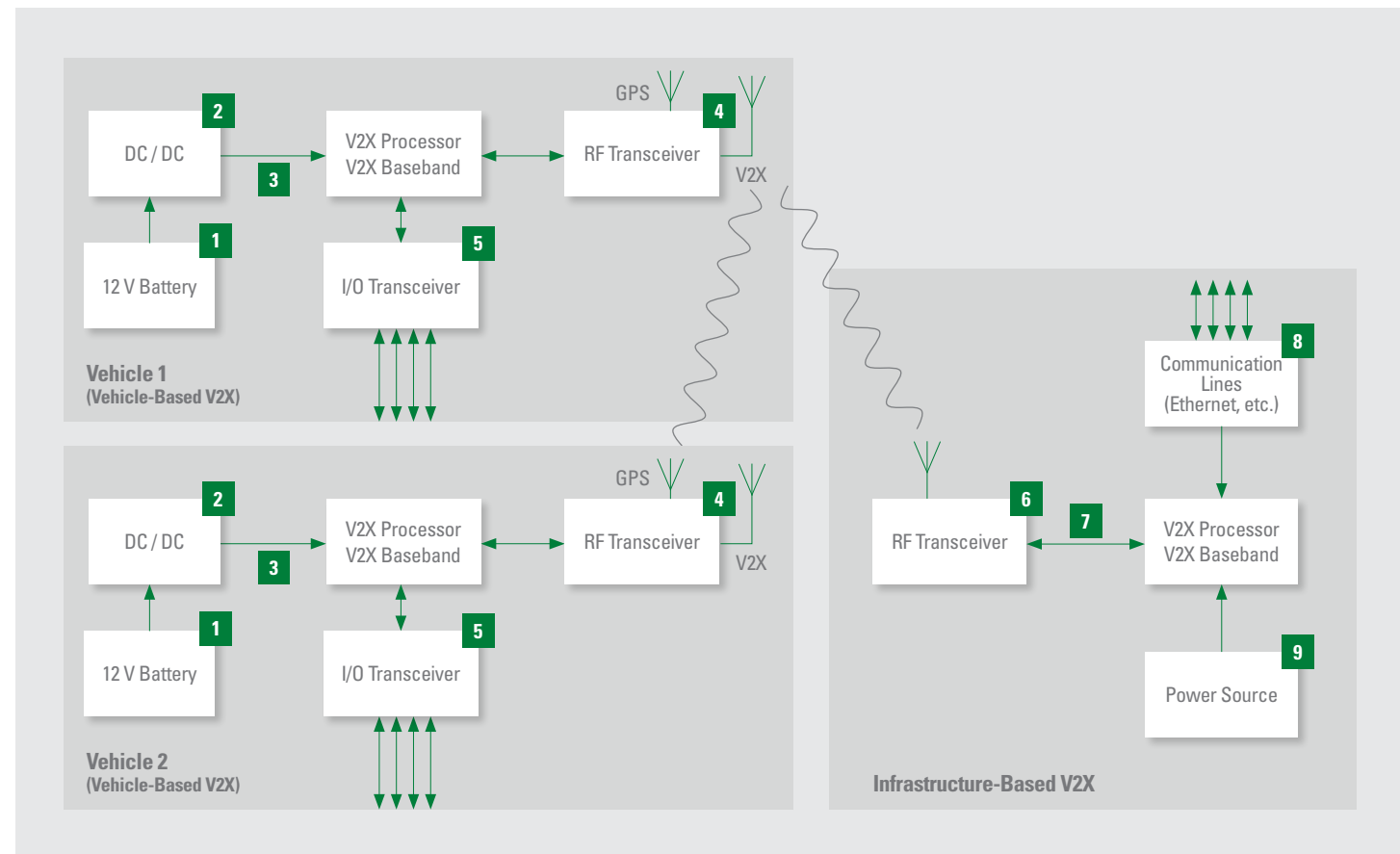

	Technology	Application	Series Name	Features
1	SMD Fuse	Short circuit protection	437A, 438A, 440A	Tested to new AECQ specification, fast response to fault current, surface mount device
	TVS Diode	Overvoltage protection	SZ1SMB, SLD8S	AEC-Q101 qualified, meets IEC standards for ESD protection and ISO for load dump protection
2	SMD PPTC	Overcurrent protection	ASMD, miniASMD	AEC-Q200 qualified, small footprint 2029/1812 size
	Schottky Diode	Reverse blocking/output rectification	DST	Ultra-Low V _f , high temperature capability, low leakage, low forward voltage drop to 100V and 10A
3	SMD PPTC	Secondary overcurrent protection	ASMD, miniASMD	AEC-Q200 qualified, small footprint 2029/1812 size
4	TVS Diode	Secondary overvoltage protection	SZ1SMA, SZ1SMB	AEC-Q101 qualified, meets IEC standards for ESD protection and ISO for load dump protection
4	Polymer ESD	ESD protection for GPS and RF antenna	AXGD	AEC-Q200 qualified, ultra-low capacitance, low leakage current
5	Diode Array	ESD protection for high-speed IO ports (ethernet, HDBaseT)	AQ3400, AQ2555	AEC-Q qualified, low capacitance, low leakage current, small form factor µDFN
6	Polymer ESD	ESD protection for RF antenna	AXGD	AEC-Q200 qualified, ultra-low capacitance, low leakage current
7	SMD Fuse	To protect baseband processor from short circuit	437A, 438A, 440A	Tested to new AECQ specification, fast response to fault current, surface mount device
	TVS Diode	To protect baseband processor from overvoltage	SZ1SMA, SZ1SMB	AEC-Q101 qualified, meets IEC standards for ESD protection and ISO for load dump protection
8	Diode Array	ESD protection against high-speed data lines on the V2X infrastructure side	AQ3400, AQ2555	AEC-Q qualified, low capacitance, low leakage current, small form factor µDFN
9	TVS Diode	Overvoltage protection for power supply on the V2X infrastructure side	SZ1SMA, SZ1SMB	AEC-Q101 qualified, meets IEC standards for ESD protection and ISO for load dump protection



EMERGENCY CALL (eCALL)

In a crash, an eCall-equipped car will automatically call the nearest emergency center to summon help. Potential electrical threats to this system include load dump, overcurrents, surges, and ESD. To ensure eCall systems operate at peak performance, Littelfuse offers protection devices like TVS Diodes and Diode Arrays, MLVs, MOVs, SMD Fuses, SMD PPTCs, and XTREME-GUARD™ ESD Suppressors.

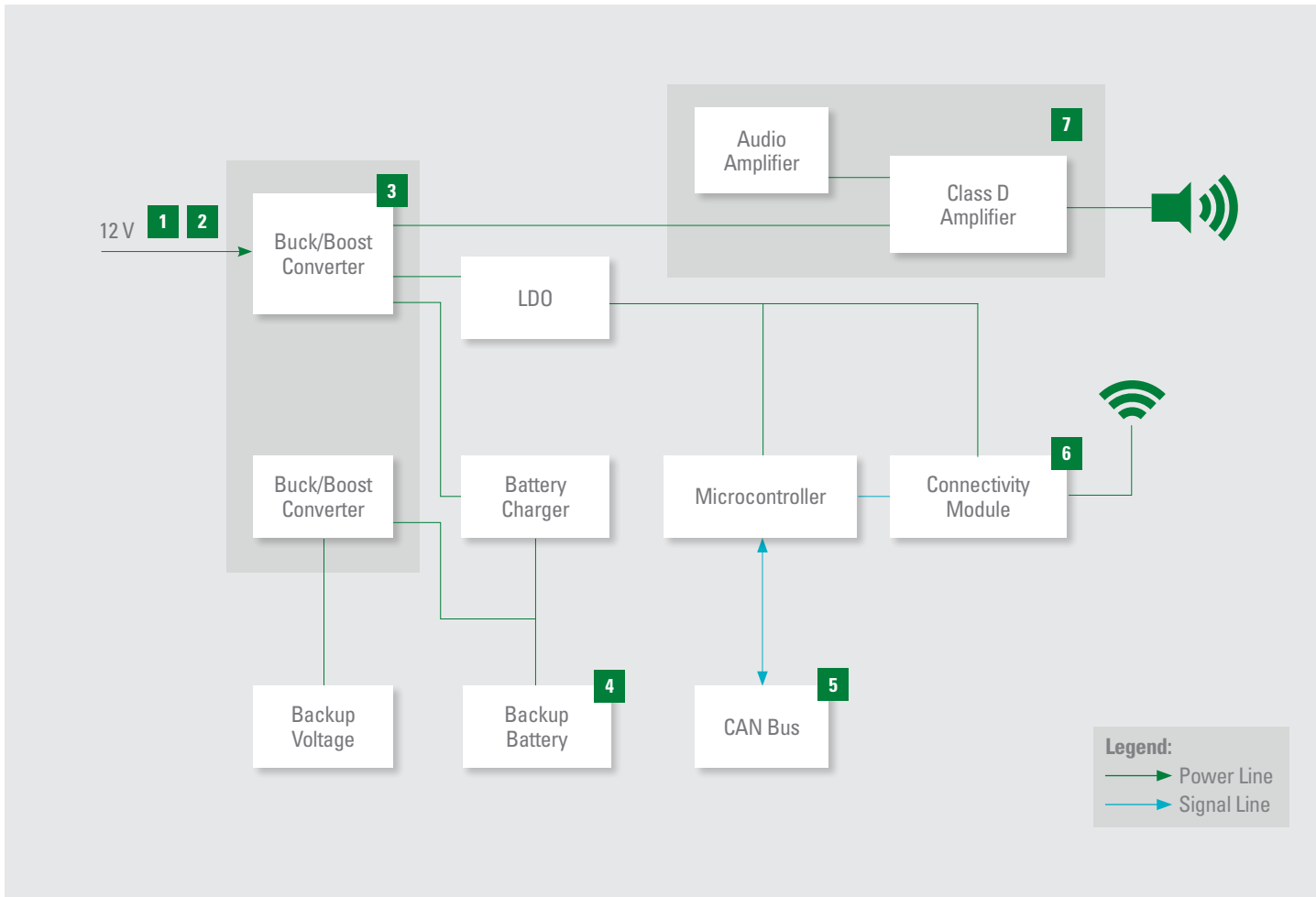

	Technology	Application	Series Name	Features
1	SMD Fuse	Short circuit protection	437A , 438A , 440A	Tested to new AECQ specification, fast response to fault current, surface mount device
2	TVS Diode	Overvoltage protection	SLD8S , SZ1SMA , SZ1SMB	AEC-Q101 qualified, meets IEC standards for ESD protection and ISO for load dump protection
	Multilayer Varistor (MLV)		AUJML , MLA Auto	AEC-Q200, load dump energy rated per SAE specification J1113, surface mount device
3	Schottky Diode	Reverse blocking/output rectification	DST	Ultra-low V _f , high temperature capability, low leakage, low forward voltage drop to 100V and 10A
4	Battery Strap PPTC	Overcurrent protection for battery	LSP380* , LR4 , SRP	AEC-Q200 qualified, multiple current and size for selection
5	Diode Array	CAN Bus ESD protection	AQ24CANA , AQ24CANFD	AEC-Q101 qualified, meets ESD protection levels specified under IEC 61000-4-2, ISO10605, low leakage current and clamping voltage
6	Polymer ESD and Silicon ESD Diode	Designed to provide protection against ESD, CDE, EFT, and lightning induced surges for high-speed data lines and antenna	AXGD , AQ3130 , AQ3118	AEC-Q qualified, low capacitance, low leakage current, small form factor
7	Diode Array	ESD protection for audio amplifier	AQ1005	Low capacitance 30pF and leakage current 0.1µA, small form factor SOD882

* Please contact us for more details



SENSOR FUSION

As designs advance closer to Level 4 and 5 self-driving vehicles, sensor data from cameras, radar, LiDAR, and GPS are becoming centralized for more-efficient processing and decision making. Protect signal lines from ESD and power lines from voltage transients and reverse polarity conditions. Littelfuse offers a broad range of protection devices including TVS Diodes, Schottky Diodes, and Diode Arrays.

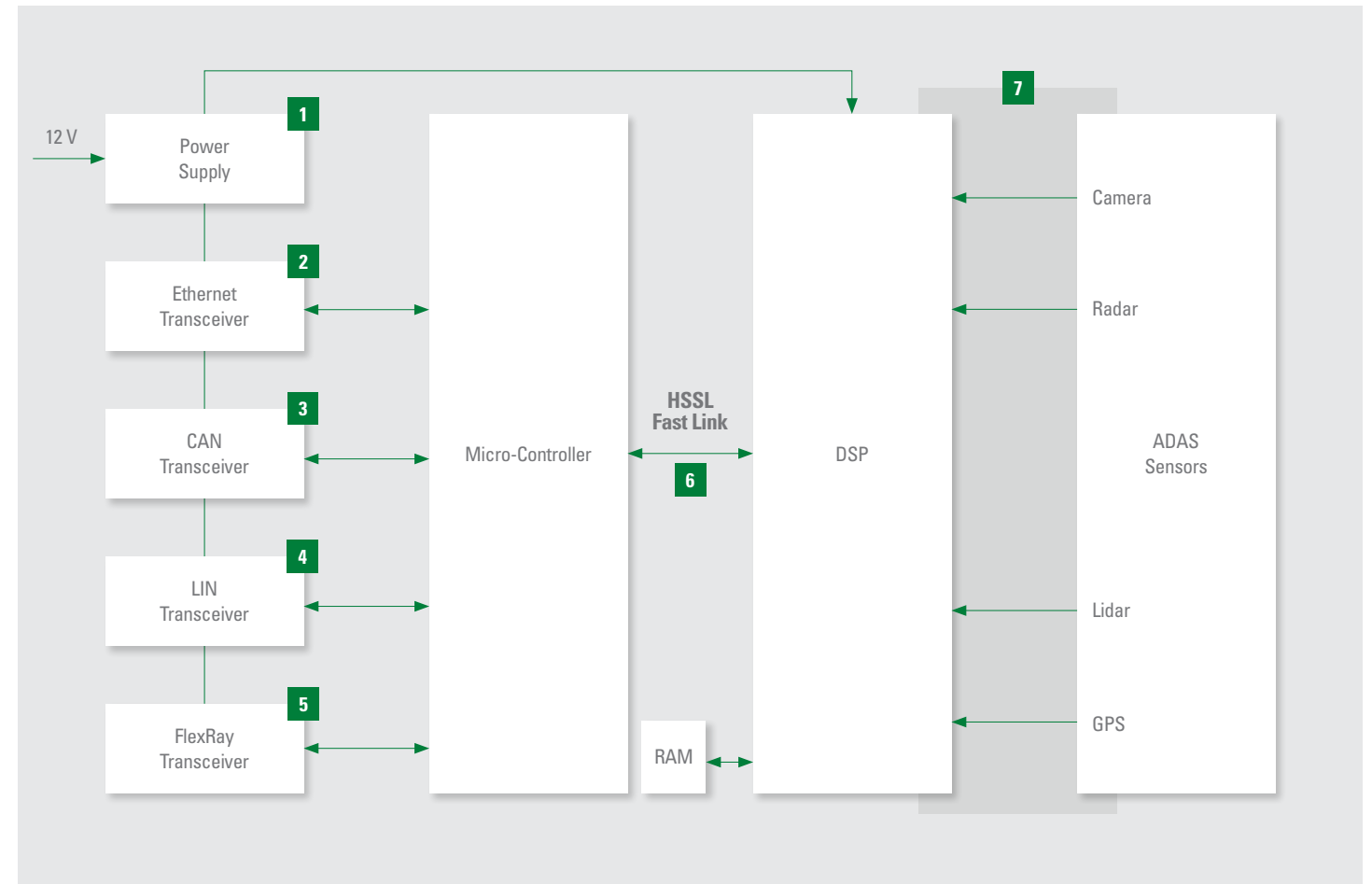

	Technology	Application	Series Name	Features
1	TVS Diode	Overvoltage protection for the power supply	SZ1SMB , SLD8S	AEC-Q101 qualified, meets IEC standards for ESD protection and ISO for load dump protection
	Schottky Diode	Reverse blocking/output rectification	DST	Ultra-low V _f , high temperature capability, low leakage, low forward voltage drop to 100V and 10A
2	Diode Array	Designed to provide protection against ESD, CDE, EFT, and lightning induced surges for high-speed data lines	AQ3400 , AQ2555	AEC-Q qualified, low capacitance (1.0pF, 2.5pF respectively), low leakage current, small form factor µDFN
3	Diode Array	Protect CAN Bus against ESD protection	AQ24CANA	AEC-Q101 qualified, meets ESD protection levels specified under IEC 61000-4-2, ISO10605, low leakage current and clamping voltage
4	Diode Array	Protect LIN Bus against ESD and surge transients	AQ24-01FTG	AEC-Q101 qualified, low clamping voltage and leakage current
5	Diode Array	Protect FlexRay Bus against ESD and surge transients	AQ24CANFD	AEC-Q101 qualified, low clamping voltage and leakage current
6	Diode Array	Protect high-speed serial link against ESD and surge transients	AQ3045	AEC-Q101 qualified, low capacitance 0.35pF and leakage current 100nA, small package
7	Diode Array	ESD protection of multiple sensor fusion inputs like GPS, lidar, radar, and camera	AQ3400	AEC-Q qualified, low capacitance, low leakage current, small form factor µDFN



RADAR SYSTEM

Vehicle radar has the crucial task of detecting the speed, distance, and direction of objects and then communicating that data to systems used for parking, emergency braking, and self-driving. Signal lines should have ESD protection, and the power supply should be protected from short circuits, overcurrents, and overvoltage. Automotive qualified components from Littelfuse include fuses, PPTCs, TVS Diodes, Diode Arrays, and Polymer ESD Suppressors.

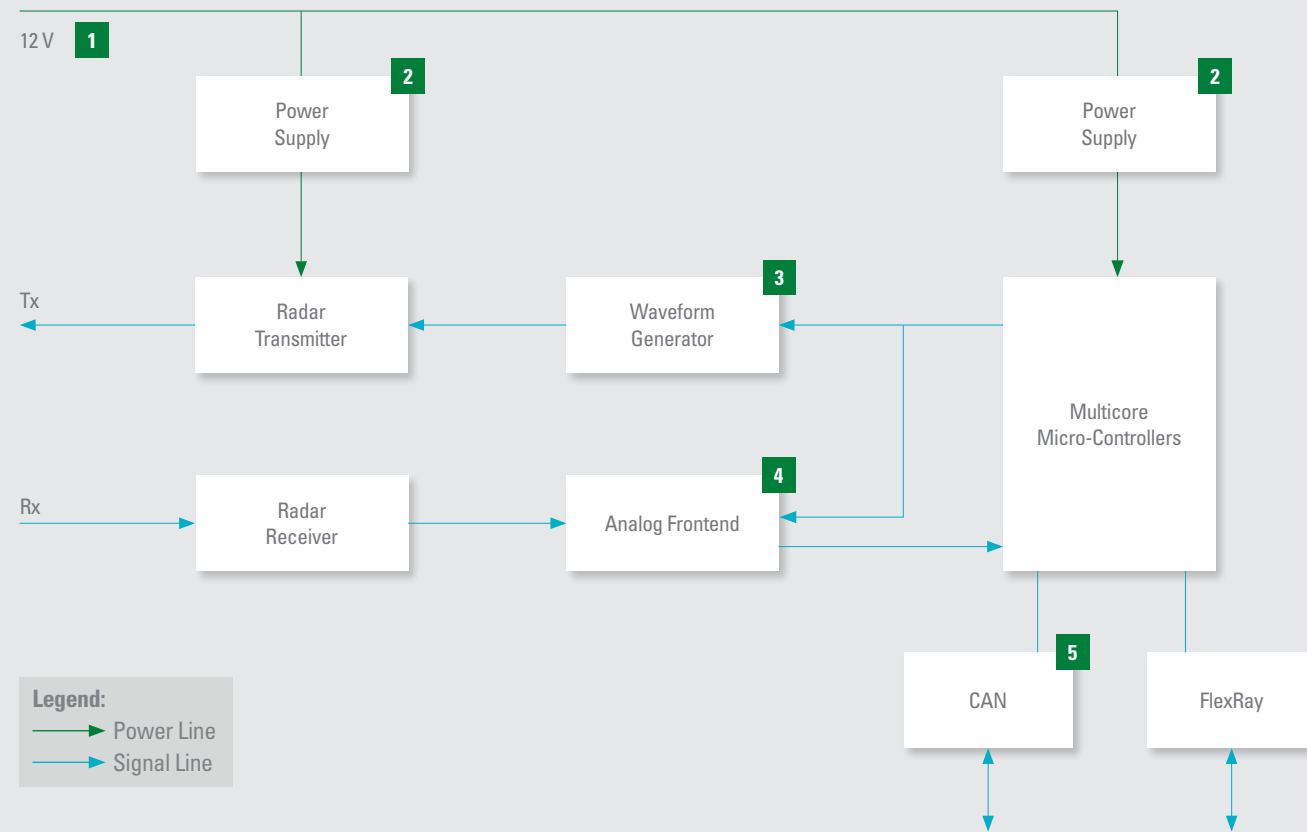

CAMERAS

External cameras support ADAS functions like Lane Departure Warning, while interior cameras support eye tracking to prevent accidents due to drowsiness of the driver. In addition to protection against common electrical threats, data and communication buses require protection that does not interfere with high-frequency video signals. Littelfuse solutions include TVS Diodes and Diode Arrays, MLVs, Schottky Diodes, and SMD PPTCs.

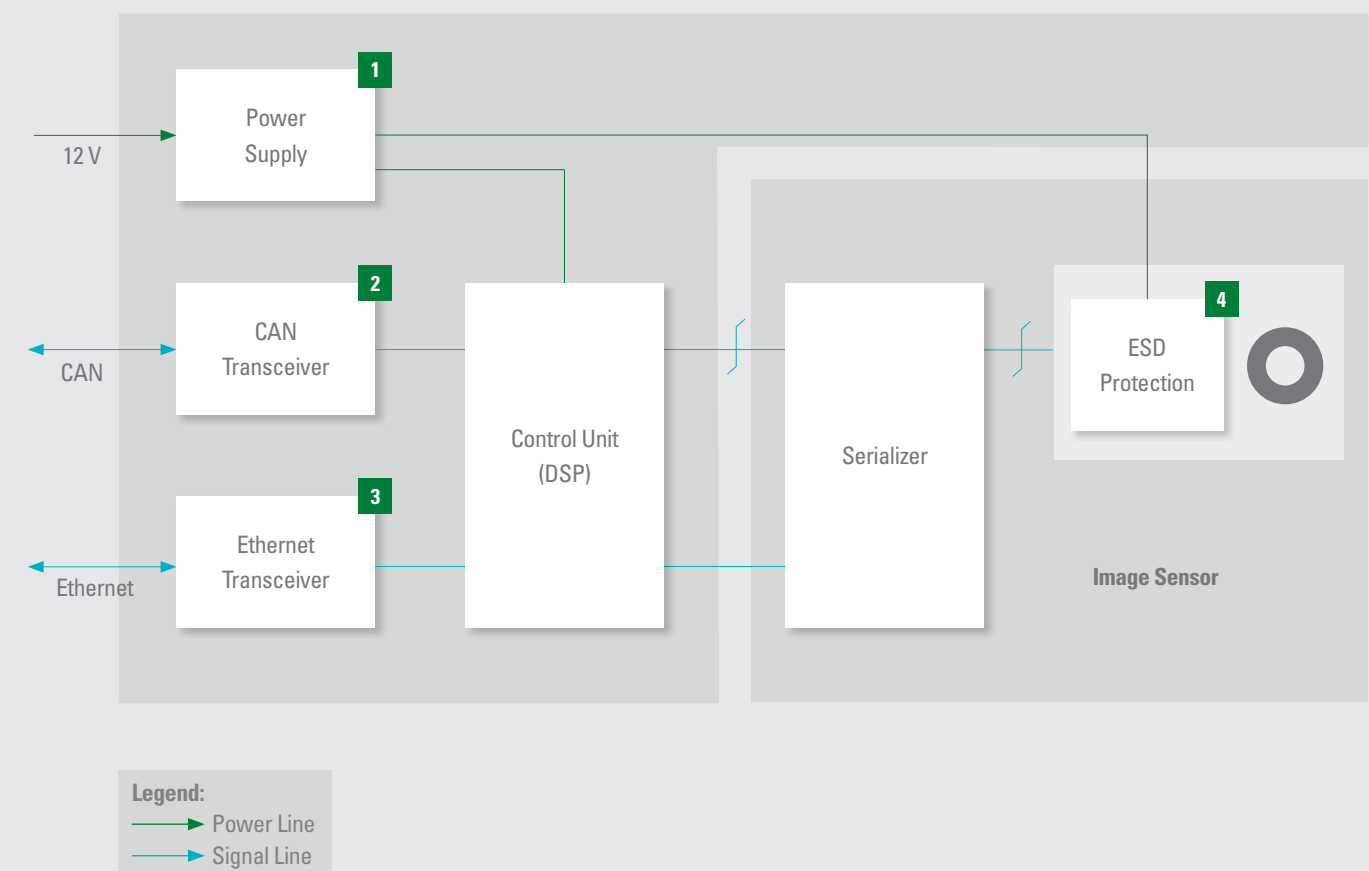

	Technology	Application	Series Name	Features
1	SMD Fuse	Short circuit protection	437A, 438A, 440A	Tested to new AECQ specification, fast response to fault current, surface mount device
	SMD PPTC	Overcurrent protection	ASMD, miniASMD	AEC-Q200 qualified, small footprint 2029/1812 size
	Schottky Diode	Reverse blocking/output rectification	DST	Ultra-low V _f , high temperature capability, low leakage, low forward voltage drop to 100V and 10A
2	TVS Diode	Overvoltage protection for the power supply	SZ1SMB, SLD8S	AEC-Q101 qualified, meets IEC standards for ESD protection and ISO for load dump protection
3	Diode Array	ESD protection for waveform generator	AQ3045	AEC-Q101 qualified, low capacitance 0.35pF and leakage current 100nA, small package
4	Polymer ESD and Silicon ESD Diode	ESD protection for analog front end	AXGD, SESD	AEC-Q qualified, low capacitance, low leakage current, small form factor
5	Diode Array	Protects CAN Bus against ESD protection	AQ24CANA, AQ24CANFD	AEC-Q101 qualified, meets ESD protection levels specified under IEC 61000-4-2, ISO10605, low leakage current and clamping voltage

	Technology	Application	Series Name	Features
1	SMD Fuse	Short circuit protection	437A, 438A, 440A	Tested to new AECQ specification, fast response to fault current, surface mount device
	SMD PPTC		ASMD, miniASMD	AEC-Q200 qualified, small footprint 2029/1812 size
	TVS Diode	Load dump protection	SZ1SMA, SZ1SMB	AEC-Q101 qualified, meets IEC standards for ESD protection and ISO for load dump protection
	Multilayer Varistor (MLV)		AUML, MLA Auto	AEC-Q200, load dump energy rated per SAE specification J1113, surface mount device
2	Schottky Diode	Reverse polarity protection	DST	Ultra-low V _f , high temperature capability, low leakage, low forward voltage drop to 100V and 10A
2	Diode Array	CAN Bus ESD protection	AQ24CANA, AQ24CANFD	AEC-Q101 qualified, meets ESD protection levels specified under IEC 61000-4-2, ISO10605, low leakage current and clamping voltage
3	Polymer ESD or Diode Array	Designed to provide protection against ESD, CDE, EFT, and lightning induced surges for high-speed data lines	AXGD, AQ3400, AQ2555	AEC-Q qualified, low capacitance (<0.1pF, 1pF, 2.5pF respectively), low leakage current, small form factor
4	Diode Array	High-speed ESD protection	AQ3045	AEC-Q101 qualified, low capacitance 0.35pF, low leakage current 100nA, small form factor SOD882

REMOTE KEYLESS ENTRY

Remote keyless entry systems include the on-board circuitry that receives signals from a remote "fob" and unlocks the doors, sounds an alarm, starts the engine, etc. These systems are exposed to electrical threats on both the powered circuits and the communication lines. Protection includes Fuses, TVS Diodes and Diode Arrays, MOVs, MLVs, and ESD Suppressors.

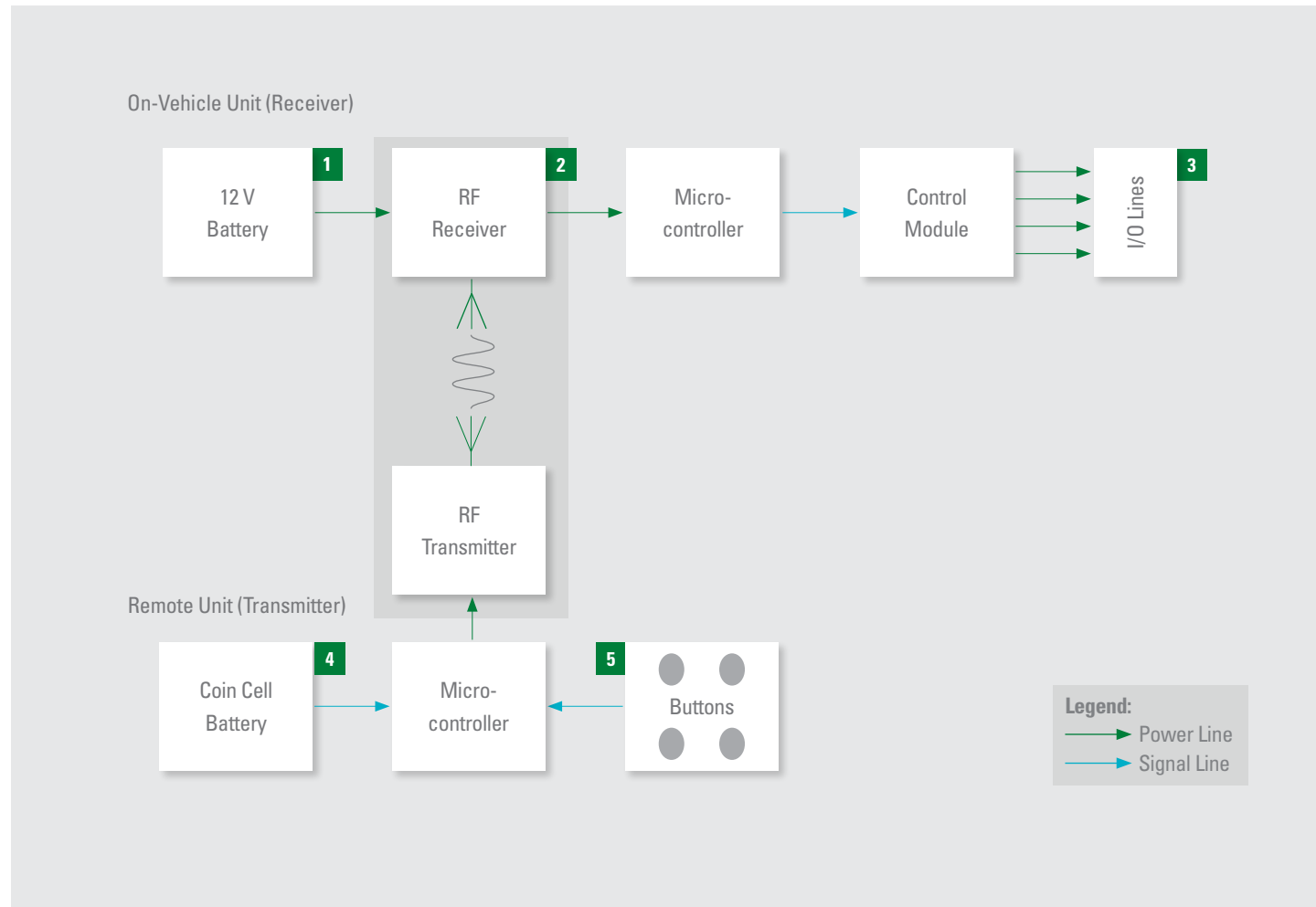

	Technology	Application	Series Name	Features
1	SMD Fuse	Overcurrent protection	437A, 440A, 441A	SMD Fuses for overcurrent protection up to 63V and 8A
	Polymer ESD	ESD protection	AXGD	Surface-mount solution for ESD and induced surge energy
2	TVS Diode	Overvoltage protection	SZ1SMA, SZ1SMB, TPSMA6L, TPSMB, TPSMC, TPSMD	TVS Diode for secondary induced transient voltages with peak pulse capability from 400W to 5000W
	Multilayer Varistor (MLV)		MLA Auto, AUML	Multilayer Varistor with load dump energy rating per SAE specification J1113
3	Diode Array	ESD/surge protection	SP3213	General purpose ESD Diodes in multiple package options and ESD capability of 30kV
	Multilayer Varistor (MLV)		MLA Auto	Voltage suppression Varistor up to 120Vdc and 8/15kV ESD capability
4	Diode Array	ESD/surge protection	SP3213	General purpose ESD Diodes in multiple package options and ESD capability of 30kV
	Multilayer Varistor (MLV)		MLA Auto	Voltage suppression Varistor up to 120Vdc and 8/15kV ESD capability
5	Diode Array	ESD/surge protection	SP3213	General purpose ESD Diodes in multiple package options and ESD capability of 30kV
	Multilayer Varistor (MLV)		MLA Auto	Voltage suppression Varistor up to 120Vdc and 8/15kV ESD capability

LIGHTING – INSIDE CABIN

Individual user settings and automatic dimming based on external light intensity are increasingly common in modern interior lighting systems. Designers must guard against load dump, surges, ESD, overcurrents, and other threats. Choose resettable PPTCs for thermal protection of LEDs; MLVs, and Diode Arrays offer ESD protection for user controls.

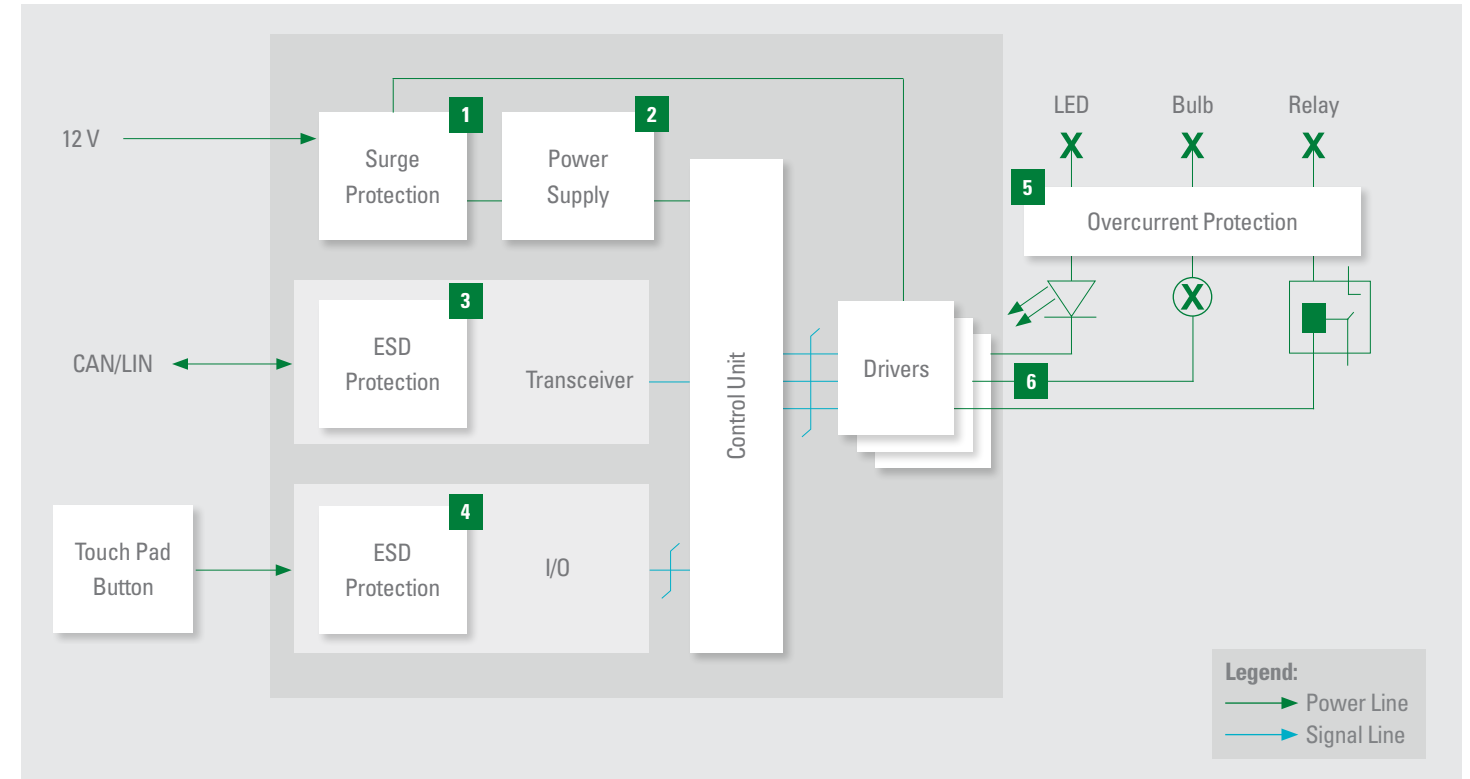

	Technology	Application	Series Name	Features
1	TVS Diode	Load dump protection	SLD&S, TPSMB	TVS Diode for ISO16750 5a/5b load dump protection
	Multilayer Varistor (MLV)		AUML	Multilayer Varistor with load dump energy rating per SAE specification J1113
	TVS Diode	Standard surge protection	SZ1SMA, SZ1SMB, TPSMA6L, TPSMB, TPSMC, TPSMD	TVS Diode for secondary induced transient voltages with peak pulse capability from 400W to 5000W
	SMD PPTC		miniASMD, ASMD, miniASMDCH	Resettable SMD overcurrent protection up to 3A
2	Schottky Diode	Reverse polarity protection	DST	Ultra-low V_f Schottky Barrier Rectifier meets the general requirements of automotive applications by providing high temperature capability, low leakage and low forward voltage drop to 100V and 10A
3	Schottky Diode	Reverse blocking/output rectification	DST	Ultra-low V_f Schottky Barrier Rectifier meets the general requirements of automotive applications by providing high temperature capability, low leakage and low forward voltage drop to 100V and 10A
	TVS Diode Array	CAN Bus ESD protection	AQ24CANA	Industry-standard solution for ESD protection on CAN Bus
4	TVS Diode Array	LIN Bus ESD protection	AQ24C	Industry-standard solution for ESD and surge protection for LIN Bus
5	TVS Diode Array	IO protection	AQ1003, AQ1005, SP1326, AQ3522	General-purpose ESD Diodes in multiple package options and ESD capability of 30kV
	Multilayer Varistor (MLV)		MLA Auto	Voltage suppression Varistor up to 120Vdc and 8/15kV ESD capability
6	SMD PPTC	Thermal protection	miniASMD, ASMD, miniASMDCH	Resettable SMD overcurrent protection up to 3A
6	LED Protector	Open circuit and overvoltage protection	PLEdXUS-A, PLEdXS-A	Automotive Open LED protectors provide a switching electronic shunt path when a single LED in an LED array fails as an open circuit and can also be used for overvoltage protection in normal mode



LIGHTING – HEADLAMPS

Advanced headlamps use LEDs for roadway illumination as well as motors to level, swivel, and shutter the high and low beams. Common threats include load dump, surges, ESD, and short circuits. Solutions include SMD Fuses, TVS Diodes and Diode Arrays, MLVs, and Schottky Diodes.

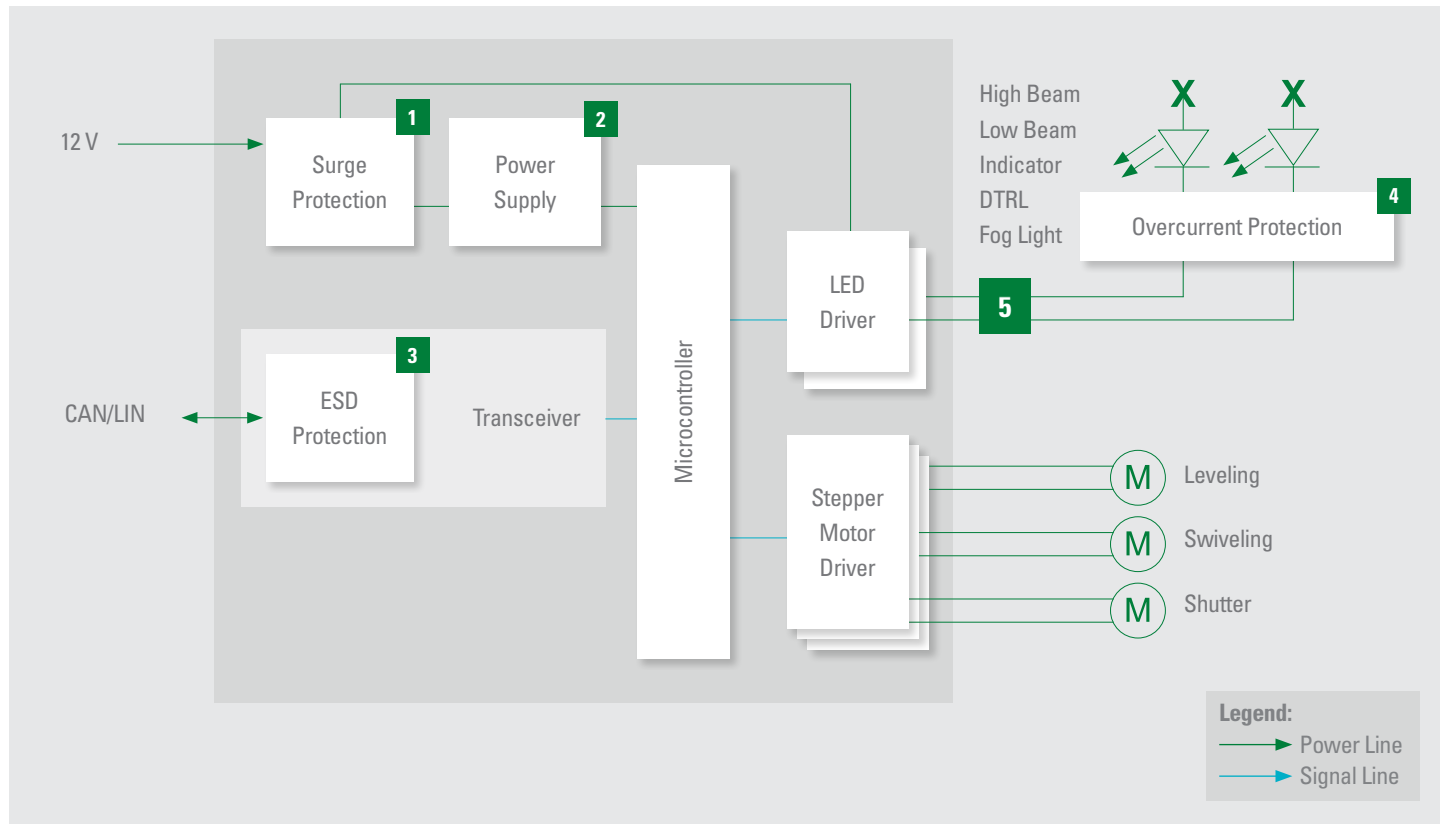

	Technology	Application	Series Name	Features
1	TVS Diode	Load dump protection	SLD8S, TPSMB	TVS Diode for ISO16750 5a/5b load dump protection
	Multilayer Varistor (MLV)		AUML	Multilayer Varistor with load dump energy rating per SAE specification J1113
	TVS Diode	Standard surge protection	SZ1SMA, SZ1SMB, TPSMAGL, TPSMB, TPSMC, TPSMD	TVS Diode for secondary induced transient voltages with peak pulse capability from 400W to 5000W
	Multilayer Varistor (MLV)		MLA Auto, AUML	Voltage suppression Varistor up to 120Vdc and 8/15kV ESD capability
	SMD PPTC	Reverse polarity protection	miniASMD, ASMD, miniASMDCH	Resettable SMD overcurrent protection up to 3A
Schottky Diode	DST		Ultra-low V_f Schottky Barrier Rectifier meets the general requirements of automotive applications by providing high temperature capability, low leakage, and low forward voltage drop to 100V and 10A	
2	Schottky Diode	Freewheeling diode	DST	Ultra-low V_f Schottky Barrier Rectifier meets the general requirements of automotive applications by providing high temperature capability, low leakage, and low forward voltage drop
3	Diode Array	CAN Bus ESD protection	AQ24CANA	Industry-standard solution for ESD protection on CAN Bus
	Diode Array	LIN Bus ESD protection	AQ24C	Industry-standard solution for ESD and surge protection for LIN Bus
4	SMD Fuse	Short Circuit protection	501A	High I ² t SMD Fuse with ratings up to 32V and 20A
5	LED Protector	Open circuit and overvoltage protection	PLEDXUS-A, PLEDxS-A	Provide a switching electronics shunt path when a single LED in an LED array fails as an open circuit and can also be used for overvoltage protection in normal mode

Global Lab Capabilities



You need to be certain that your products live up to the highest standards for performance, reliability, safety, and regulatory compliance. Working with Littelfuse, you have access to dedicated application engineers who partner with you to provide expert design consultation, perform comprehensive tests simulating the harshest environments, and confidentially evaluate the results in consultation with you.

TESTING CAPABILITIES

Environmental

- Autoclave
- Dust
- H3TRB
- HAST
- High- and Low-Temperature Storage
- High-Temperature Loading
- Ingress Protection (IP)
- HTGB
- HTRB
- Temperature and Humidity
- Temperature Cycling
- Thermal Shock
- Salt Fog

Physical-Mechanical Characteristics

- Acceleration
- Die Shear
- Leak Detection
- Mechanical Shock
- Resistance to Soldering Heat (Dip, Reflow, Wave)
- Resistance to Solvents
- Solderability
- Terminal Strength (Push, Pull, Bend)
- Vibration
- Wetting Balance
- Wire Pull

Electrical

- BCI
- Capacitance
- EFT
- ESD
- Impedance
- Insulation Resistance
- I-V
- Life
- Lightning Surge
- Overload
- Parametric Tests
- Power-Cross
- Power Cycling
- Ring Wave
- R-T
- S-Parameter Measurements (Insertion Loss, Isolation, Reflection)
- Short Circuit
- Step Current
- Surface Resistivity
- Surge
- TDR (Eye Diagram)
- Telecom
- Thermal Cut-Off
- Time-to-Trip
- TLP
- Transient
- Trip Cycle
- Trip Endurance
- Voltage Drop



Scan or click to download

To access this guide and other **Littelfuse** literature in an interactive and mobile-friendly format, please visit our **eCatalog** library.

©2020 Littelfuse, Inc. Information furnished is believed to be accurate and reliable. However, users should independently evaluate the suitability of and test each product selected for their own applications. Littelfuse products are not designed for, and may not be used in, all applications. Read complete Disclaimer Notice at www.littelfuse.com/about-us/disclaimer/electronics-products.

Disclaimer: Littelfuse products are not designed for, and shall not be used for, any purpose (including, without limitation, automotive, military, aerospace, medical, life-saving, life-sustaining or nuclear facility applications, devices intended for surgical implant into the body, or any other application in which the failure or lack of desired operation of the product may result in personal injury, death, or property damage) other than those expressly set forth in applicable Littelfuse product documentation. Warranties granted by Littelfuse shall be deemed void for products used for any purpose not expressly set forth in applicable Littelfuse documentation. Littelfuse shall not be liable for any claims or damages arising out of products used in applications not expressly intended by Littelfuse as set forth in applicable Littelfuse documentation. The sale and use of Littelfuse products is subject to Littelfuse Terms and Conditions of Sale, unless otherwise agreed by Littelfuse.

LOCAL RESOURCES FOR A GLOBAL MARKET

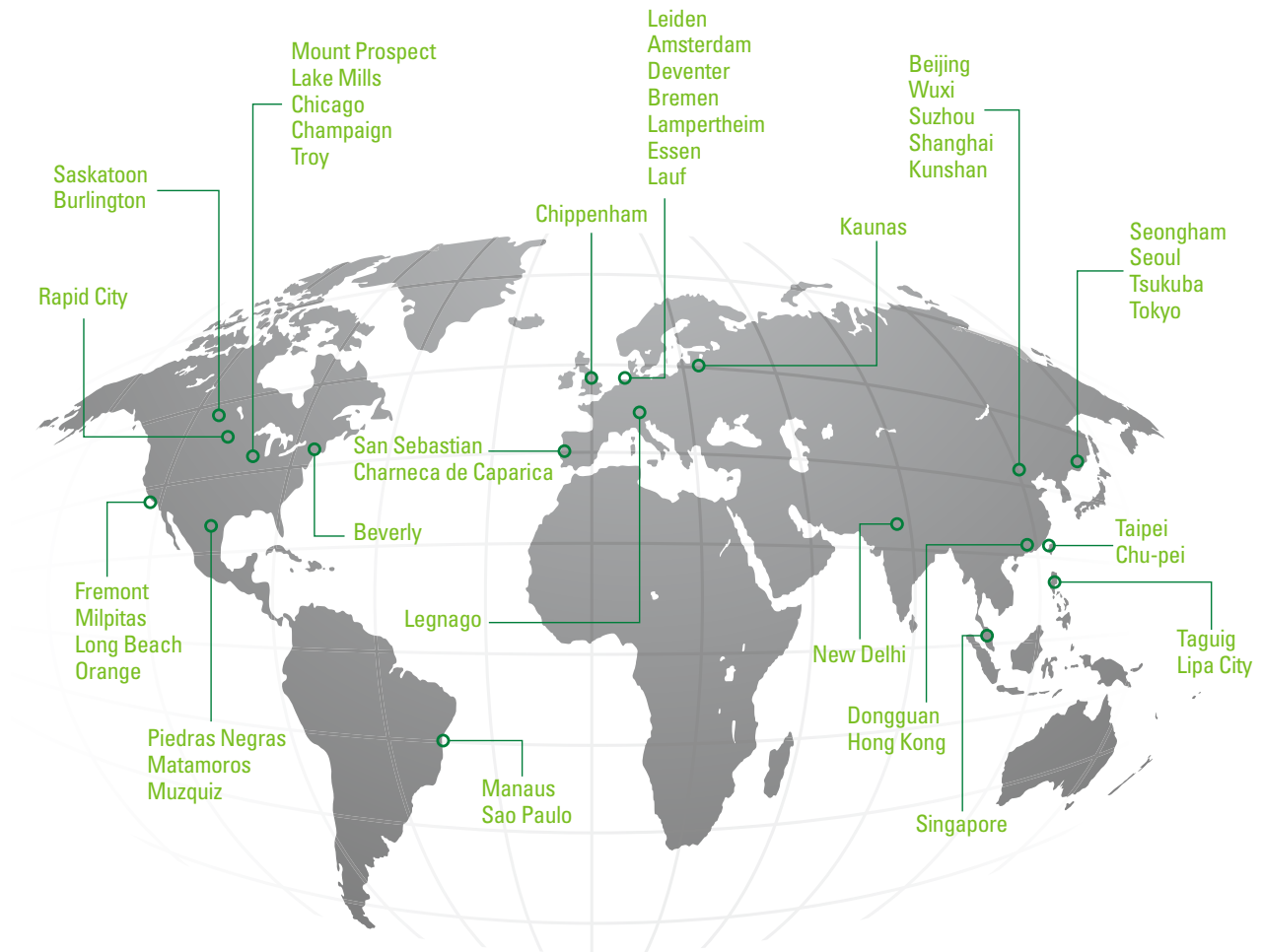

Littelfuse products are certified to many standards around the world. To check certifications on specific products, please refer to the product datasheet on [Littelfuse.com](https://www.littelfuse.com).



Expertise Applied | Answers Delivered