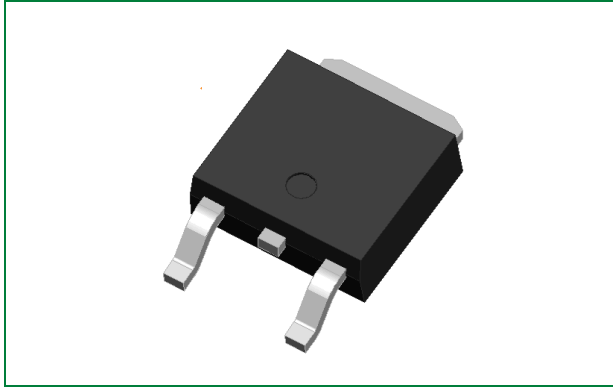


# LGD18N45TH

## 450 V, 18 A N-Channel Ignition IGBT



### Product Summary

Characteristic	Value	Unit
$V_{CES}$	450	V
$I_c$	18	A

### Description

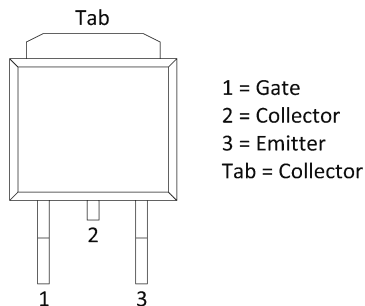
This Logic Level Insulated Gate Bipolar Transistor (IGBT) features monolithic circuitry integrating ESD and Over-Voltage clamped protection for use in inductive coil drivers applications. Primary uses include Ignition, Direct Fuel Injection, or wherever high voltage and high current switching is required.

### Agency Approvals

Environmental Approvals



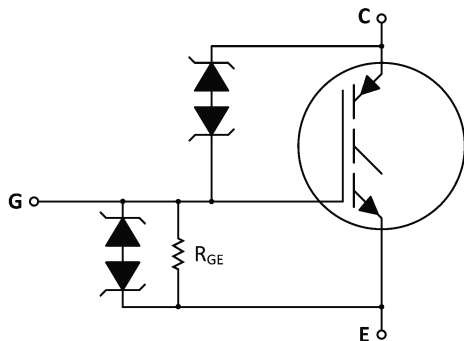
### Pinout Diagram



### Features

- Ideal for Coil-on-Plug Applications
- DPAK Package Offers Smaller Footprint for Increased Board Space
- Gate-Emitter ESD Protection
- Temperature Compensated Gate-Collector Voltage Clamp Limits Stress Applied to Load
- Low Threshold Voltage Interfaces Power Loads to Logic or Microprocessor Devices
- Low Saturation Voltage
- High Pulsed Current Capability
- AEC-Q101 Qualified
- These are Pb-Free Devices
- Emitter Ballasting for Short-Circuit Capability

### Functional Diagram



1. Maximum Ratings ( $T_J = 25\text{ }^\circ\text{C}$ unless otherwise specified) .....	3
2. Unclamped Collector-to-Emitter Avalanche Characteristics .....	3
3. Maximum Short-Circuit Times .....	3
4. Thermal Characteristics .....	3
5. Electrical Characteristics – Off .....	4
6. Electrical Characteristics – On .....	4
7. Dynamic Characteristics .....	4
8. Switching Characteristics .....	5
9. Figure Data .....	6
10. Package Dimensions .....	9
11. Part Numbering and Marking .....	10
12. Packing Options .....	10

## 1. Maximum Ratings (T<sub>J</sub> = 25 °C unless otherwise specified)

Characteristic	Conditions	Symbol	Value	Unit
Collector-Emitter Voltage	-	V <sub>CES</sub>	500	V <sub>DC</sub>
Gate-Gate Voltage	-	V <sub>CER</sub>	500	V <sub>DC</sub>
Gate-Emitter Voltage	-	V <sub>GE</sub>	18	V <sub>DC</sub>
Collector Current – Continuous	T <sub>C</sub> = 25 °C	I <sub>C</sub>	18	A <sub>DC</sub>
Collector Current – Pulsed			50	A <sub>AC</sub>
ESD – Human Body Model	R = 1500 Ω, C = 100 pF	ESD	8.0	kV
ESD – Machine Model	R = 0 Ω, C = 200 pF		400	V
Total Power Dissipation	T <sub>C</sub> = 25 °C	P <sub>D</sub>	115	W
	Derating for > 25 °C		0.77	W/°C
Operating and Storage Temperature Range	-	T <sub>J</sub> , T <sub>stg</sub>	-55 to +175	°C

## 2. Unclamped Collector-to-Emitter Avalanche Characteristics

Characteristic	Symbol	Value	Unit
Single Pulse Collector-to-Emitter Avalanche Energy			
V <sub>CC</sub> = 50 V, V <sub>GE</sub> = 5.0 V, P <sub>kL</sub> = 26.0 A, L = 1.0 mH, Starting T <sub>J</sub> = 25 °C	E <sub>AS</sub>	338	mJ
V <sub>CC</sub> = 50 V, V <sub>GE</sub> = 5.0 V, P <sub>kL</sub> = 10.0 A, L = 8.4 mH, Starting T <sub>J</sub> = 25 °C		420	
V <sub>CC</sub> = 50 V, V <sub>GE</sub> = 5.0 V, P <sub>kL</sub> = 15.4 A, L = 2.0 mH, Starting T <sub>J</sub> = 150 °C		237	
V <sub>CC</sub> = 50 V, V <sub>GE</sub> = 5.0 V, P <sub>kL</sub> = 5.7 A, L = 15.2 mH, Starting T <sub>J</sub> = 150 °C		247	

## 3. Maximum Short-Circuit Times

Characteristic	Symbol	Value	Unit
Short Circuit Withstand Time 1 (T <sub>A</sub> = 105 °C) <sup>1</sup>	t <sub>sc,1-1</sub>	1000	μs
Short Circuit Withstand Time 1 (T <sub>A</sub> = 150 °C) <sup>1</sup>	t <sub>sc,1-2</sub>	800	μs
Short Circuit Withstand Time 2 (T <sub>A</sub> = 105 °C) <sup>2</sup>	t <sub>sc,2-1</sub>	5.0	ms
Short Circuit Withstand Time 2 (T <sub>A</sub> = 150 °C) <sup>2</sup>	t <sub>sc,2-2</sub>	1.0	ms

Footnote 1: See Figure 17, 3 pulses with 10 ms period

Footnote 2: See Figure 18, 3 pulses with 10 ms period

## 4. Thermal Characteristics

Characteristic	Symbol	Value	Unit
Thermal Resistance, Junction to Case	R <sub>θJC</sub>	1.3	°C/W
Thermal Resistance, Junction to Ambient (DPAK) <sup>3</sup>	R <sub>θJA</sub>	95	°C/W
Maximum Lead Temperature for Soldering Purposes, 1/8" from case for 5 seconds	T <sub>L</sub>	275	°C

Footnote 3: When surface mounted to an FR4 board using the minimum recommended pad size

## 5. Electrical Characteristics – Off

Characteristic	Symbol	Conditions	Temperature	Value			Unit
				Min	Typ	Max	
Collector-Emitter Clamp Voltage	BV <sub>CES</sub>	I <sub>C</sub> = 2.0 mA	T <sub>J</sub> = -40 °C to 150 °C	430	455	470	V <sub>DC</sub>
		I <sub>C</sub> = 10 mA		440	475	500	
Zero Gate Voltage Collector Current	I <sub>CES</sub>	V <sub>CE</sub> = 15 V, V <sub>GE</sub> = 0 V	T <sub>J</sub> = 25 °C	-	-	2.0	μA <sub>DC</sub>
			T <sub>J</sub> = 150 °C	-	0.5	20	
		V <sub>CE</sub> = 350 V, V <sub>GE</sub> = 0 V	T <sub>J</sub> = 150 °C	-	75	250	
			T <sub>J</sub> = -40 °C	-	0.2	10	
Reverse Collector-Emitter Leakage Current	I <sub>ECS</sub>	V <sub>CE</sub> = -24 V	T <sub>J</sub> = 25 °C	-	0.7	1.0	mA
			T <sub>J</sub> = 150 °C	-	12	25	
			T <sub>J</sub> = -40 °C	-	0.1	1.0	
Reverse Collector-Emitter Clamp Voltage	BV <sub>CES(R)</sub>	I <sub>C</sub> = -75 mA	T <sub>J</sub> = 25 °C	24	27	30	V <sub>DC</sub>
			T <sub>J</sub> = 150 °C	26	29	33	
			T <sub>J</sub> = -40 °C	23	26	29	
Gate-Emitter Clamp Voltage	BV <sub>GES</sub>	I <sub>G</sub> = 5.0 mA	T <sub>J</sub> = -40 °C to 150 °C	11	13	15	V <sub>DC</sub>
Gate-Emitter Leakage Current	I <sub>GES</sub>	V <sub>GE</sub> = ±10 V	T <sub>J</sub> = -40 °C to 150 °C	384	590	700	μA <sub>DC</sub>
Gate-Emitter Resistor	R <sub>GE</sub>	-	T <sub>J</sub> = -40 °C to 150 °C	10	16	26	kΩ
Gate Resistor	R <sub>G</sub>	-	T <sub>J</sub> = -40 °C to 150 °C	-	70	-	Ω

## 6. Electrical Characteristics – On

Characteristic	Symbol	Conditions	Temperature	Value			Unit
				Min	Typ	Max	
Gate Threshold Voltage	V <sub>GE(th)</sub>	I <sub>C</sub> = 1.0 mA, V <sub>GE</sub> = V <sub>CE</sub>	T <sub>J</sub> = 25 °C	1.1	1.56	1.9	V <sub>DC</sub>
			T <sub>J</sub> = 150 °C	0.75	1.08	1.4	
			T <sub>J</sub> = -40 °C	1.2	1.75	2.1	
Threshold Temperature Coefficient (Negative)	-	-	-	-	3.5	-	mV/°C
Collector-Emitter On-Voltage	V <sub>CE(on)</sub>	I <sub>C</sub> = 7.0 A, V <sub>GE</sub> = 4.5 V	T <sub>J</sub> = -40 °C to 150 °C	1.10	1.84	2.30	V <sub>DC</sub>
		I <sub>C</sub> = 7.0 A, V <sub>GE</sub> = 4.0 V	T <sub>J</sub> = -40 °C to 150 °C	1.15	1.89	2.35	
		I <sub>C</sub> = 7.0 A, V <sub>GE</sub> = 3.7 V	T <sub>J</sub> = -40 °C to 150 °C	1.20	1.93	2.50	
		I <sub>C</sub> = 10 A, V <sub>GE</sub> = 4.5 V	T <sub>J</sub> = -40 °C to 150 °C	1.45	2.07	2.65	
		I <sub>C</sub> = 10 A, V <sub>GE</sub> = 4.0 V	T <sub>J</sub> = -40 °C to 150 °C	1.50	2.13	2.80	
		I <sub>C</sub> = 10 A, V <sub>GE</sub> = 3.7 V	T <sub>J</sub> = -40 °C to 150 °C	1.55	2.19	2.85	
		I <sub>C</sub> = 10 mA, V <sub>GE</sub> = 4.5 V	T <sub>J</sub> = -40 °C to 150 °C	-	0.65	1.00	
Forward Transconductance	g <sub>fs</sub>	V <sub>CS</sub> = 5.0 V, I <sub>C</sub> = 6.0 A	T <sub>J</sub> = -40 °C to 150 °C	6.0	14	25	Mhos

## 7. Dynamic Characteristics

Characteristic	Symbol	Conditions	Temperature	Value			Unit
				Min	Typ	Max	
Input Capacitance	C <sub>ISS</sub>	V <sub>CC</sub> = 25 V, V <sub>GE</sub> = 0 V, f = 1.0 MHz	T <sub>J</sub> = -40 °C to 150 °C	400	780	1000	pF
Output Capacitance	C <sub>OSS</sub>			50	72	100	
Transfer Capacitance	C <sub>RSS</sub>			4	6	10	

## 8. Switching Characteristics

Characteristic	Symbol	Conditions	Temperature	Value			Unit
				Min	Typ	Max	
Turn-off Delay Time	$t_{d(off)}$	$V_{CC} = 300\text{ V}, V_{GE} = 0\text{ V}, R_G = 1.0\text{ k}\Omega, R_L = 46\ \Omega$	$T_J = 25\text{ }^\circ\text{C}$	1.0	2.9	12	$\mu\text{s}$
Fall Time	$t_f$	$V_{CC} = 300\text{ V}, V_{GE} = 5\text{ V}, R_G = 1.0\text{ k}\Omega, R_L = 46\ \Omega$		1.0	2.5	7.0	
Turn-on Delay Time	$t_{d(on)}$	$V_{CC} = 14\text{ V}, V_{GE} = 5\text{ V}, R_G = 1.0\text{ k}\Omega, R_L = 1\ \Omega$	$T_J = 25\text{ }^\circ\text{C}$	0.1	0.42	1.4	$\mu\text{s}$
Rise Time	$t_r$	$V_{CC} = 14\text{ V}, V_{GE} = 5\text{ V}, R_G = 1.0\text{ k}\Omega, R_L = 1\ \Omega$		1.0	2.5	9.0	

## 9. Figure Data

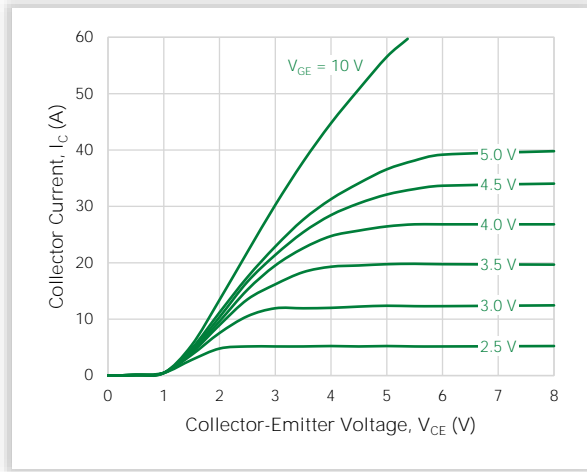
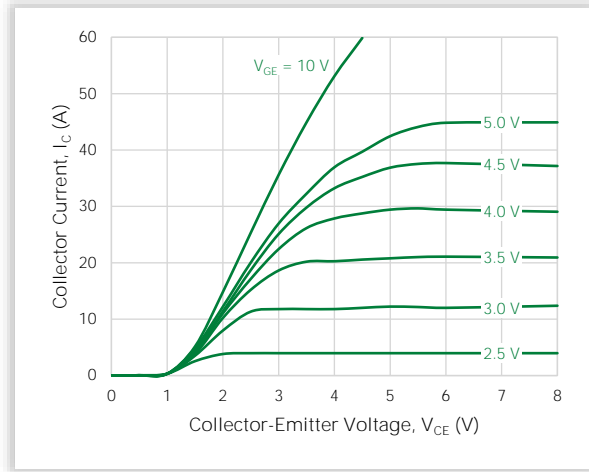
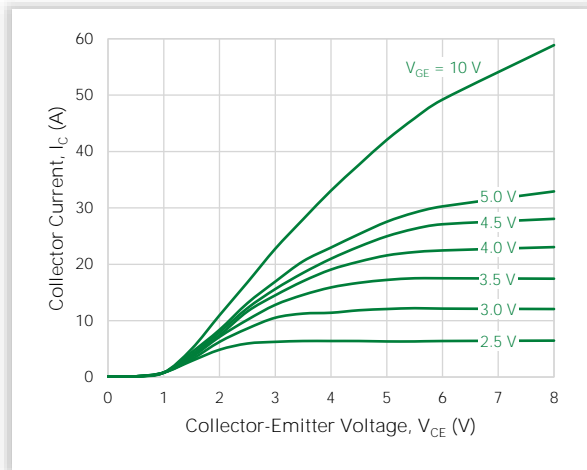
 Figure 1. Output Characteristics ( $T_J = 25\text{ }^\circ\text{C}$ )

 Figure 2. Output Characteristics ( $T_J = -40\text{ }^\circ\text{C}$ )

 Figure 3. Output Characteristics ( $T_J = 150\text{ }^\circ\text{C}$ )


Figure 4. Transfer Characteristics

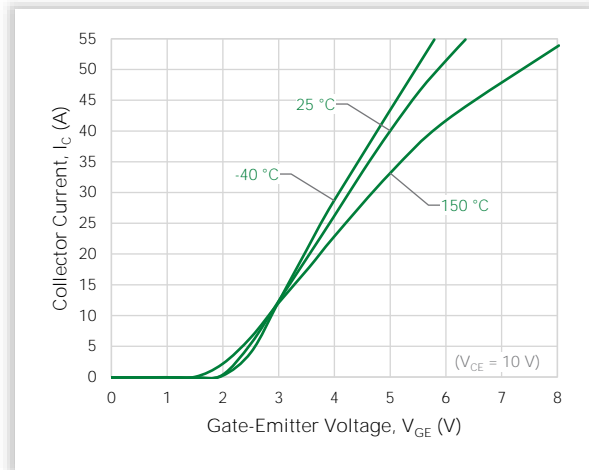


Figure 5. Collector-Emitter Saturation Voltage vs. Junction Temperature

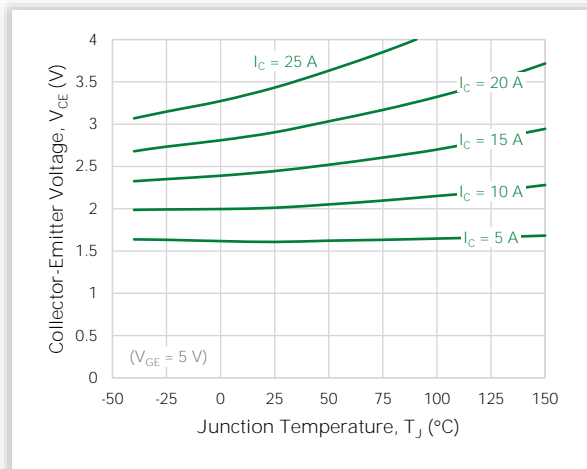
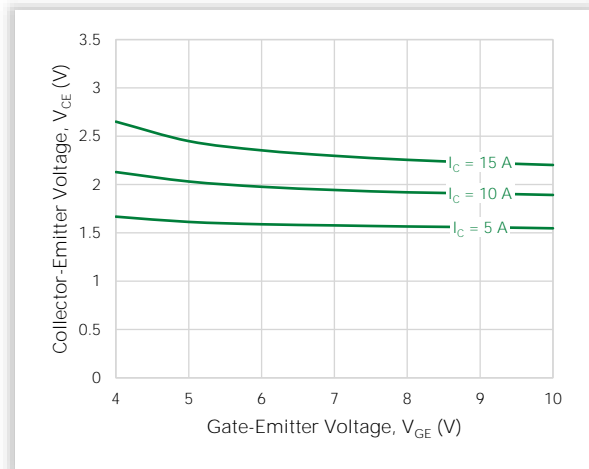

 Figure 6. Collector-Emitter Voltage vs. Gate-Emitter Voltage ( $T_J = 25\text{ }^\circ\text{C}$ )


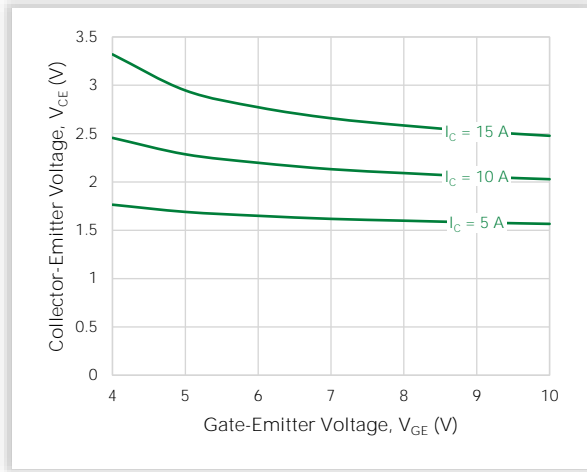
Figure 7. Collector-Emitter Voltage vs. Gate-Emitter Voltage ( $T_J = 150\text{ }^\circ\text{C}$ )


Figure 8. Capacitance Variation

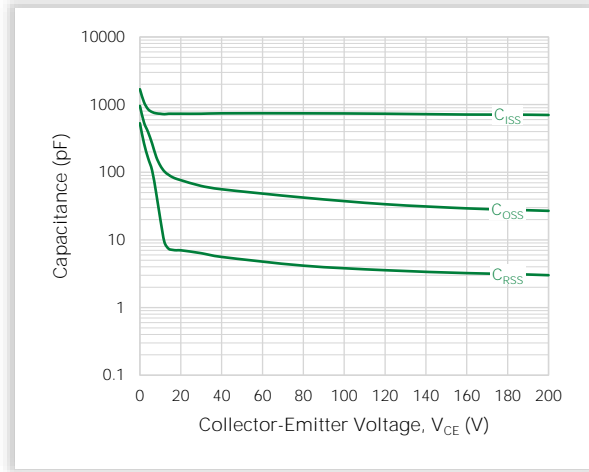


Figure 9. Gate Threshold Voltage vs. Temperature

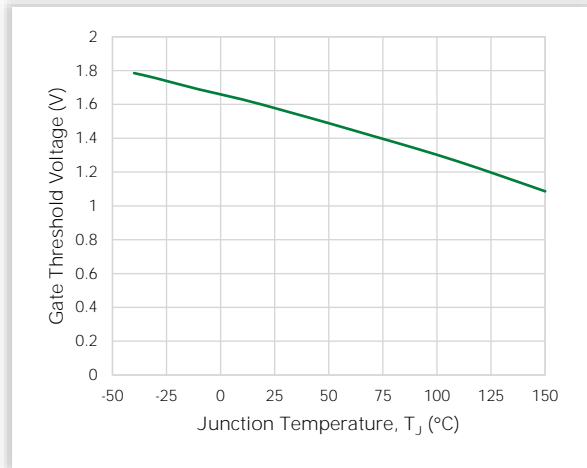


Figure 10. Minimum Open Secondary Latch Current vs. Inductance

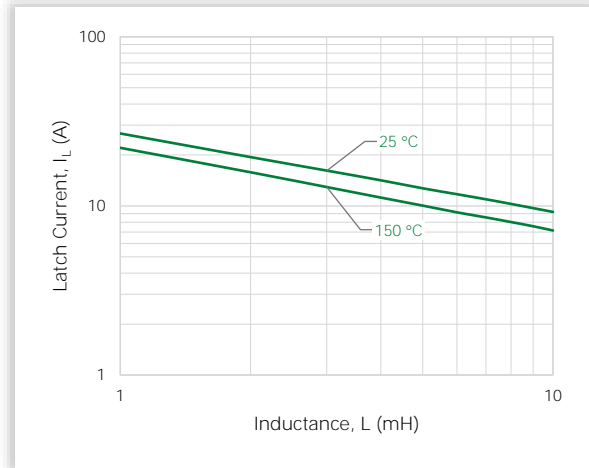


Figure 11. Typical Open Secondary Latch Current vs. Inductance

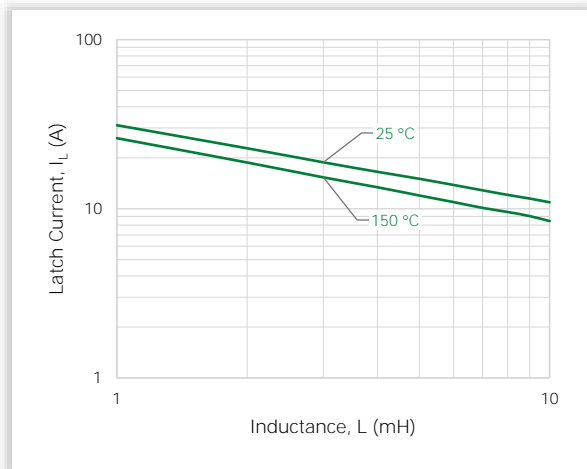


Figure 12. Inductive Switching Fall Time vs. Temperature

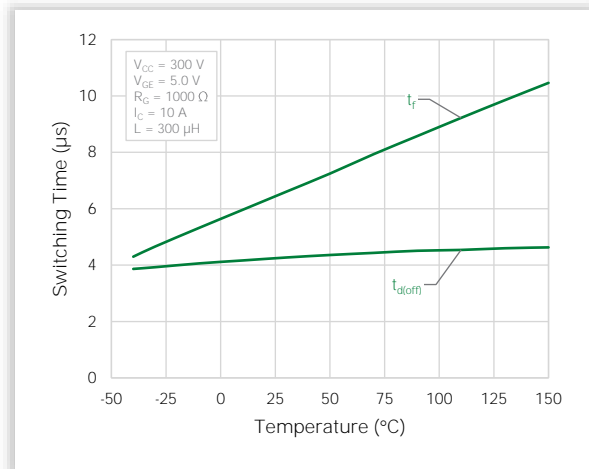


Figure 13. Single Pulse Safe Operating Area  
(Mounted on an Infinite Heatsink at  $T_A = 25^\circ\text{C}$ )

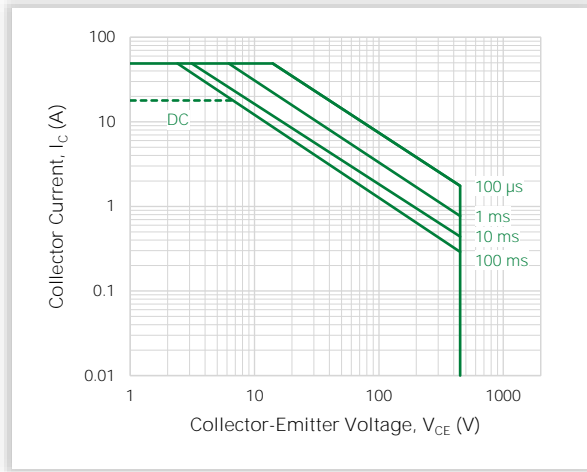


Figure 14. Single Pulse Safe Operating Area  
(Mounted on an Infinite Heatsink at  $T_A = 125^\circ\text{C}$ )

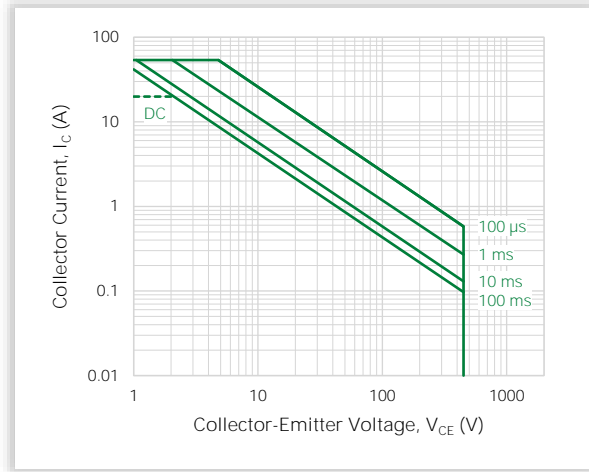


Figure 15. Pulse Train Safe Operating Area  
(Mounted on an Infinite Heatsink at  $T_A = 25^\circ\text{C}$ )

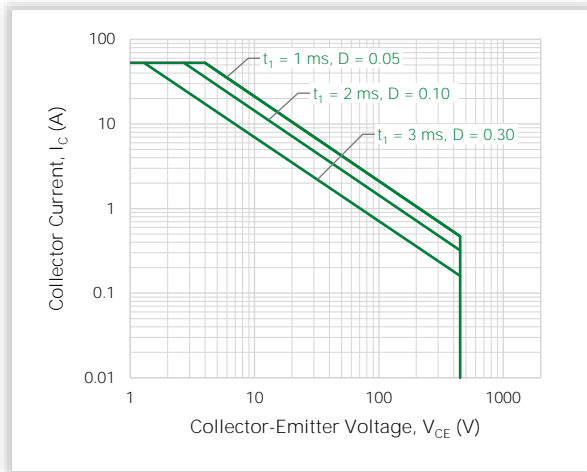


Figure 16. Pulse Train Safe Operating Area  
(Mounted on an Infinite Heatsink at  $T_A = 125^\circ\text{C}$ )

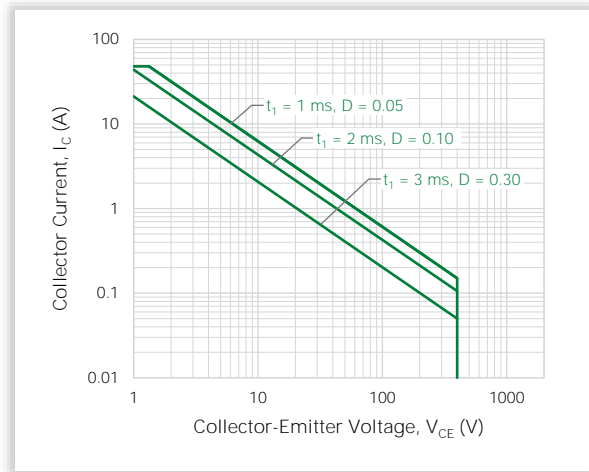


Figure 17. Circuit Configuration for Short Circuit Test 1

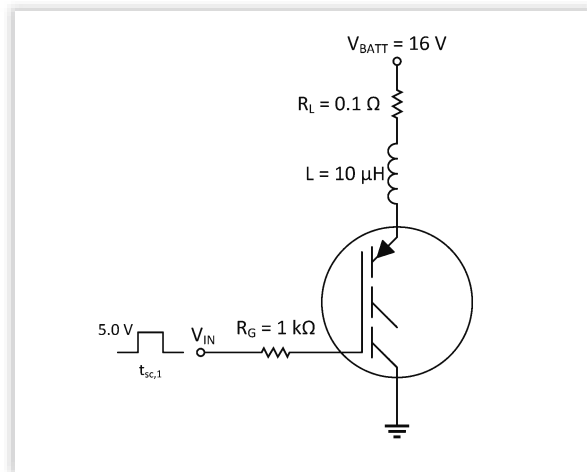


Figure 18. Circuit Configuration for Short Circuit Test 2

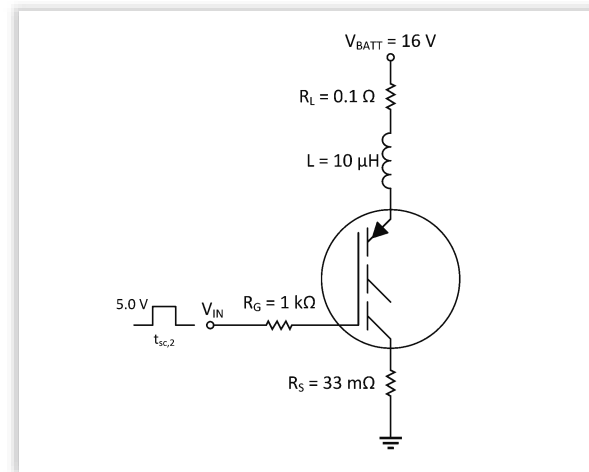
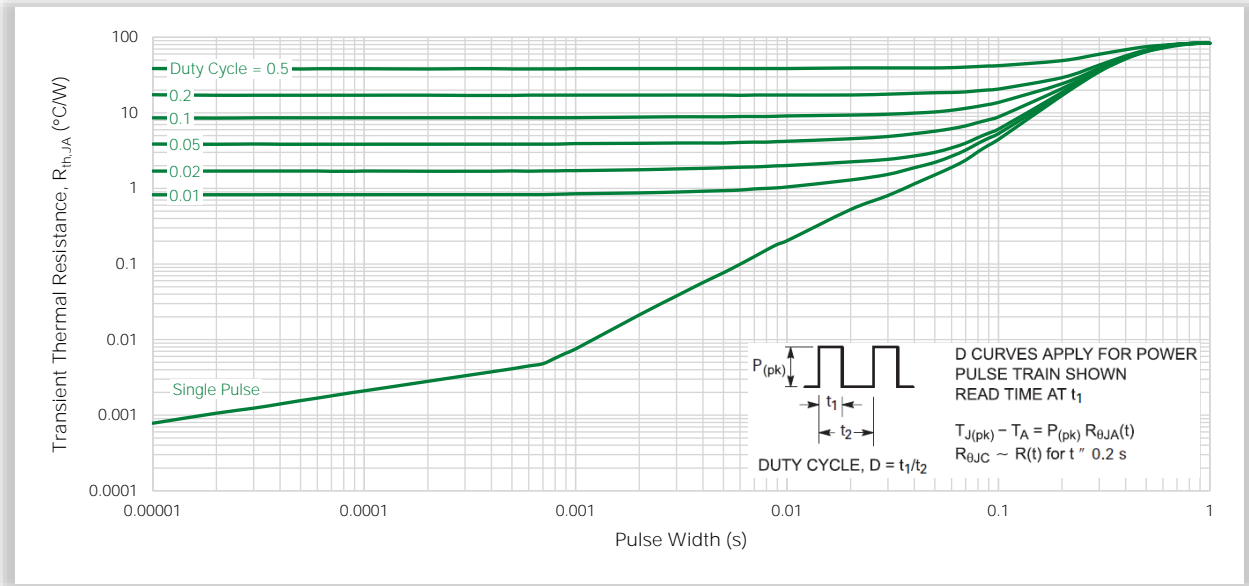


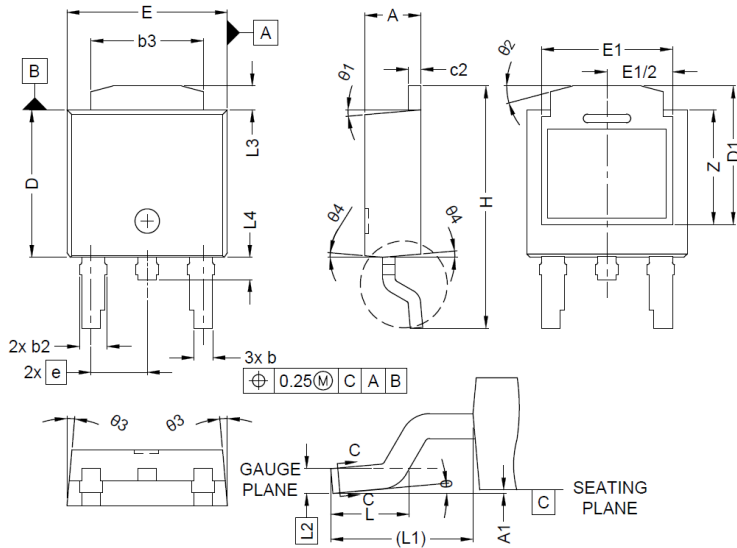


Figure 19. Transient Thermal Resistance

(Non-normalized Junction-Ambient mounted on minimum pad area)

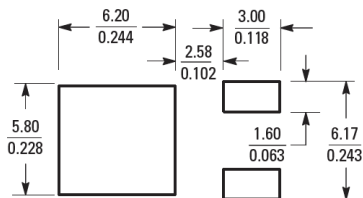


### 10. Package Dimensions



Symbol	Millimeters		
	Min	Nom	Max
A	2.18	-	2.38
A1	0.00	-	0.13
b	0.63	-	0.89
b2	0.72	-	1.14
b3	4.57	-	5.46
c	0.46	-	0.61
c2	0.46	-	0.61
D	5.97	-	6.22
D1	5.45	-	5.85
E	6.35	-	6.73
E1	5.14	-	5.54
e	2.29 BSC		
H	9.40	-	10.41
L	1.40	-	1.78
L1	2.90 REF		
L2	0.51 BSC		
L3	0.89	-	1.27
L4	-	-	1.01
Z	3.93	-	-
θ	0°	-	10°
θ1	0°	-	10°
θ2	10°	-	20°
θ3	0°	-	10°
θ4	0°	-	10°

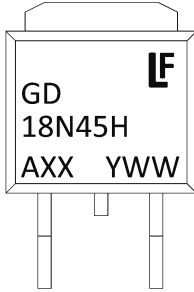
Recommended Solder Pad Layout:



Notes:

1. DIMENSIONING & TOLERANCEING CONFIRM TO ASME Y14.5M-1994.
2. ALL DIMENSIONS ARE IN MILLIMETERS. ANGLES ARE IN DEGREES.
3. HEAT SINK SIDE FLASH IS MAX. 0.8mm .
4. RADIUS ON TERMINAL IS OPTIONAL.

## 11. Part Numbering and Marking



GD18N45H = Device Code  
 A = Assembly Location  
 XX = Lot Number  
 Y = Year  
 WW = Work Week  
 H = Ballast Structure Design

## 12. Packing Options

Part Number	Package	Packing Mode	M.O.Q.
LGD18N45TH	DPAK (Pb-Free)	Tape & Reel	2500

For additional information please visit [www.Littelfuse.com/powersemi](http://www.Littelfuse.com/powersemi)

Disclaimer Notice - Littelfuse products are not designed for, and shall not be used for, any purpose (including, without limitation, automotive, military, aerospace, medical, life-saving, life-sustaining or nuclear facility applications, devices intended for surgical implant into the body, or any other application in which the failure or lack of desired operation of the product may result in personal injury, death, or property damage) other than those expressly forth in applicable Littelfuse product documentation. Littelfuse shall not be liable for any claims or damages arising out of products used in applications not expressly intended by Littelfuse as set forth in applicable Littelfuse documentation.

Read complete Disclaimer Notice at [www.littelfuse.com/disclaimer-electronics](http://www.littelfuse.com/disclaimer-electronics)